

USER'S MANUAL
Of
Intel Q77 Express Chipset
Based
M/B for LGA 1155 Quad Core Ready
Intel Core Processor

No. G03-NMF93-F

Rev: 1.0

Release date: June 5, 2012

Trademark:

* Specifications and Information contained in this documentation are furnished for information use only, and are subject to change at any time without notice, and should not be construed as a commitment by manufacturer.

TABLE OF CONTENT

ENVIRONMENTAL SAFETY INSTRUCTION.....	iii
ENVIRONMENTAL PROTECTION ANNOUCEMENT.....	iii
USER'S NOTICE	iv
MANUAL REVISION INFORMATION.....	iv
ITEM CHECKLIST	iv
CHAPTER 1 INTRODUCTION OF THE MOTHERBOARD	
1-1 SPECIFICATION.....	1
1-2 LAYOUT DIAGRAM.....	2
CHAPTER 2 HARDWARE INSTALLATION	
2-1 JUMPER SETTING	5
2-2 CONNECTORS AND HEADERS.....	7
2-2-1 REAR I/O BACK PANEL CONNECTORS.....	7
2-2-2 MOTHERBOARD INTERNAL CONNECTORS	8
2-2-3 HEADER PIN DEFINITION	10
CHAPTER 3 INTRODUCING BIOS	
3-1 ENTERNING SETUP.....	16
3-2 BIOS MENU SCREEN	16
3-3 FUNCTION KEYS	17
3-4 GETTING HELP	17
3-5 MENU BARS	18
3-6 MAIN MENU	18
3-7 ADVANCED MENU.....	19
3-8 CHIPSET MENU.....	25
3-9 BOOT MENU.....	28
3-10 SECURITY MENU	29
3-11 SAVE & EXIT MENU.....	30



Environmental Safety Instruction

- Avoid the dusty, humidity and temperature extremes. Do not place the product in any area where it may become wet.
- 0 to 40 centigrade is the suitable temperature. (The figure comes from the request of the main chipset)
- Generally speaking, dramatic changes in temperature may lead to contact malfunction and crackles due to constant thermal expansion and contraction from the 'welding spots' that connect components and PCB. Computer should go through an adaptive phase before it boots when it is moved from a cold environment to a warmer one to avoid condensation phenomenon. These water drops attached on PCB or the surface of the components can bring about phenomena as minor as computer instability resulted from corrosion and oxidation from components and PCB or as major as short circuit that can burn the components. Suggest starting the computer until the temperature goes up.
- The increasing temperature of the capacitor may decrease the life of computer. Using the close case may decrease the life of other device because the higher temperature in the inner of the case.
- Attention to the heat sink when you over-clocking. The higher temperature may decrease the life of the device and burned the capacitor.

Environmental Protection Announcement

Do not dispose this electronic device into the trash while discarding. To minimize pollution and ensure environment protection of mother earth, please recycle.



USER'S NOTICE

COPYRIGHT OF THIS MANUAL BELONGS TO THE MANUFACTURER. NO PART OF THIS MANUAL, INCLUDING THE PRODUCTS AND SOFTWARE DESCRIBED IN IT MAY BE REPRODUCED, TRANSMITTED OR TRANSLATED INTO ANY LANGUAGE IN ANY FORM OR BY ANY MEANS WITHOUT WRITTEN PERMISSION OF THE MANUFACTURER.

THIS MANUAL CONTAINS ALL INFORMATION REQUIRED TO USE THIS MOTHER-BOARD SERIES AND WE DO ASSURE THIS MANUAL MEETS USER'S REQUIREMENT BUT WILL CHANGE, CORRECT ANY TIME WITHOUT NOTICE. MANUFACTURER PROVIDES THIS MANUAL "AS IS" WITHOUT WARRANTY OF ANY KIND, AND WILL NOT BE LIABLE FOR ANY INDIRECT, SPECIAL, INCIDENTAL OR CONSEQUENTIAL DAMAGES (INCLUDING DAMAGES FOR LOSS OF PROFIT, LOSS OF BUSINESS, LOSS OF USE OF DATA, INTERRUPTION OF BUSINESS AND THE LIKE).

PRODUCTS AND CORPORATE NAMES APPEARING IN THIS MANUAL MAY OR MAY NOT BE REGISTERED TRADEMARKS OR COPYRIGHTS OF THEIR RESPECTIVE COMPANIES, AND THEY ARE USED ONLY FOR IDENTIFICATION OR EXPLANATION AND TO THE OWNER'S BENEFIT, WITHOUT INTENT TO INFRINGE.

Manual Revision Information

Reversion	Revision History	Date
1.0	First Edition	June 5, 2012

Item Checklist

- Motherboard
- User's Manual
- DVD for motherboard utilities
- Cable(s)
- I/O Back panel shield

Chapter 1

Introduction of the Motherboard

1-1 Specification

Spec	Description
Design	<ul style="list-style-type: none"> ● u-ATX form factor; PCB size: 24.4 x24.4 cm
Chipset	<ul style="list-style-type: none"> ● Intel Q77 Express Chipset
LGA1155 CPU Socket	<ul style="list-style-type: none"> ● Supports 3rd and 2nd Generation Intel[®] Core™ i7, Core™ i5, Core™ i3 series processor in LAG1155 Package <i>* for detailed CPU support information please visit our website</i>
Memory Slot	<ul style="list-style-type: none"> ● DDRIII RAM module slot x 4 ● Supporting four DDRIII 1600/1333/1066MHz RAM Module expandable to 32 GB (Maximum) ● Support dual-channel function
Expansion Slots	<ul style="list-style-type: none"> ● 1 pcs* PCI-Express x16 slot ● 1 pcs* PCI-Express x4 slot ● 1 pcs* PCI-Express x1 slot ● 1 pcs *32-bit PCI slot ● 1 pcs* Full-size Mini-PCIE slot/MSATA slot
Storage	<ul style="list-style-type: none"> ● Support two SATAIII ports and four SATAII ports with RAID 0/1/5/10 function
Dual LAN Chip	<ul style="list-style-type: none"> ● Integrated Intel 82574L and 82579LM Gigabit Ethernet LAN chip that supports Fast Ethernet LAN function of providing 10/100/1000Mbps Ethernet data transfer rate
HD Audio Chip	<ul style="list-style-type: none"> ● Realtek ALC662 6-channel Audio Codec integrated ● Audio driver and utility included
BIOS	<ul style="list-style-type: none"> ● 64MB DIP Flash ROM
Multi I/O	<ul style="list-style-type: none"> ● USB 3.0 port connector x2 ● HDMI port connector x1 ● Serial port connector x2 ● DVI-D port connector x1 ● VGA port connector x1 ● USB 2.0 port connector x4 ● RJ-45 port LAN connector x2 ● Audio connector x3 (Line-in, Line-out, MIC) ● Front panel audio header x1 ● HDMI-SPDIF header x1 ● PS/2 keyboard & mouse header x1 ● Parallel header x1 ● TPM 1.2 header x1 ● GPIO header x1 ● USB 2.0 header x2 (Support 4* additional USB 2.0 ports) ● USB 3.0 header x1 (Support 2* additional USB 3.0 ports) ● Front panel header x1 ● POWER LED header x1 ● Speaker header x1 ● CIR header x1 ● LANLED header x2 ● SM_BUS header x1 ● TX-RX COM header x 1 ● COM port header x 8

1-2 Layout Diagram

Rear IO Diagram

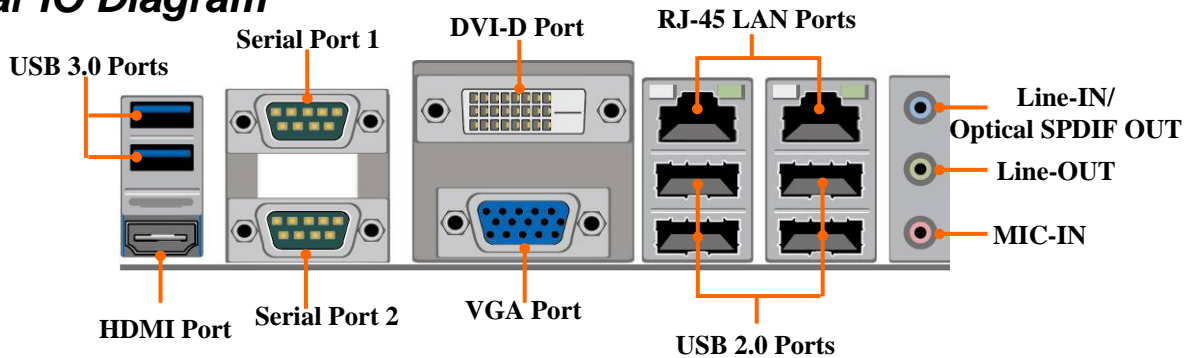

Motherboard Internal Diagram

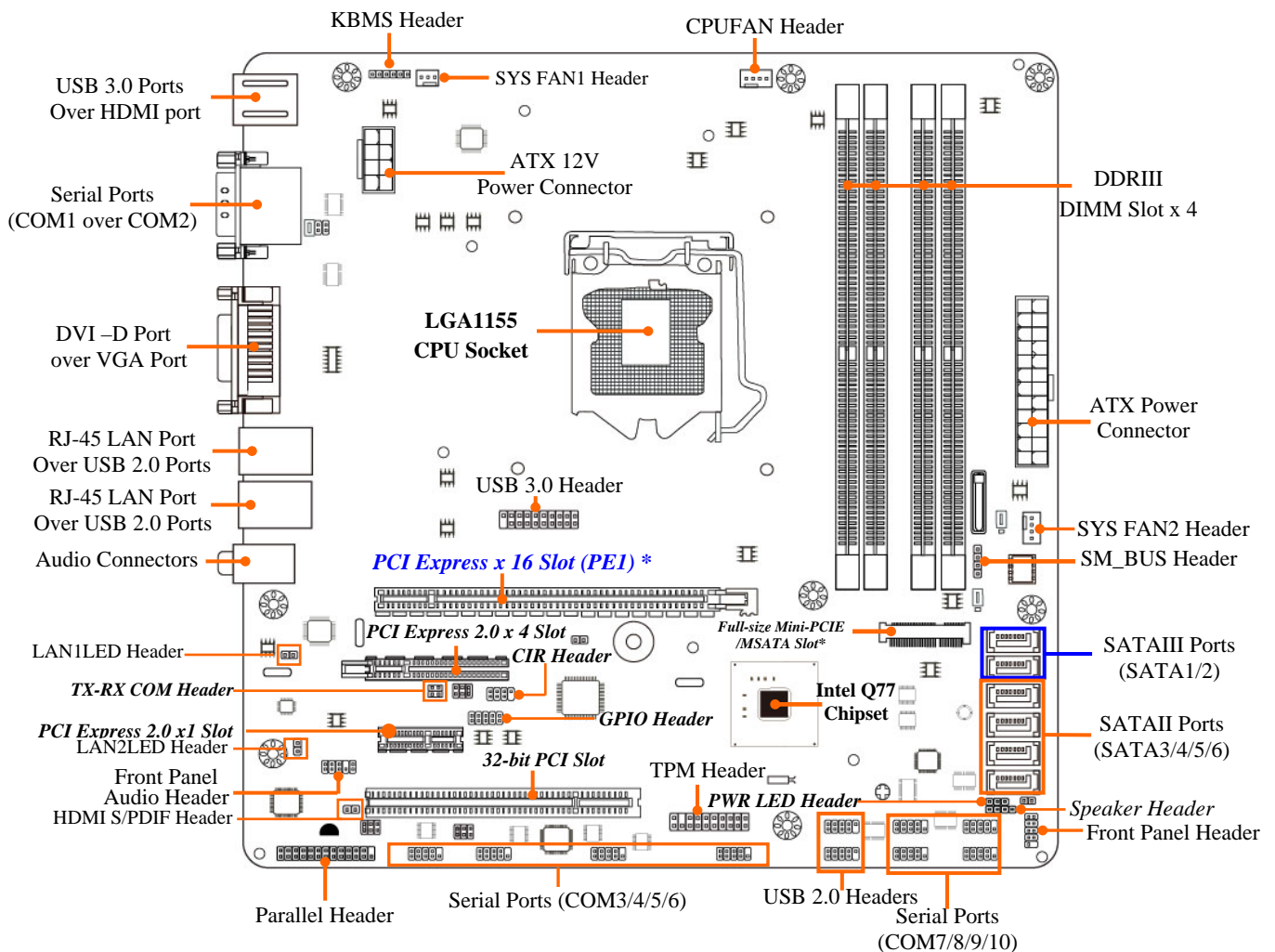

***Note:**

1. PE1 slot supports PCI-Express 2.0 x16 specification when using Intel® Sandy Bridge CPU and supports PCI-Express 3.0 x16 specification when using Intel® Ivy Bridge CPU; 2. mSATA slot is selectable with full size MINI PCI-E and share with SATA6;

Motherboard Jumper Position

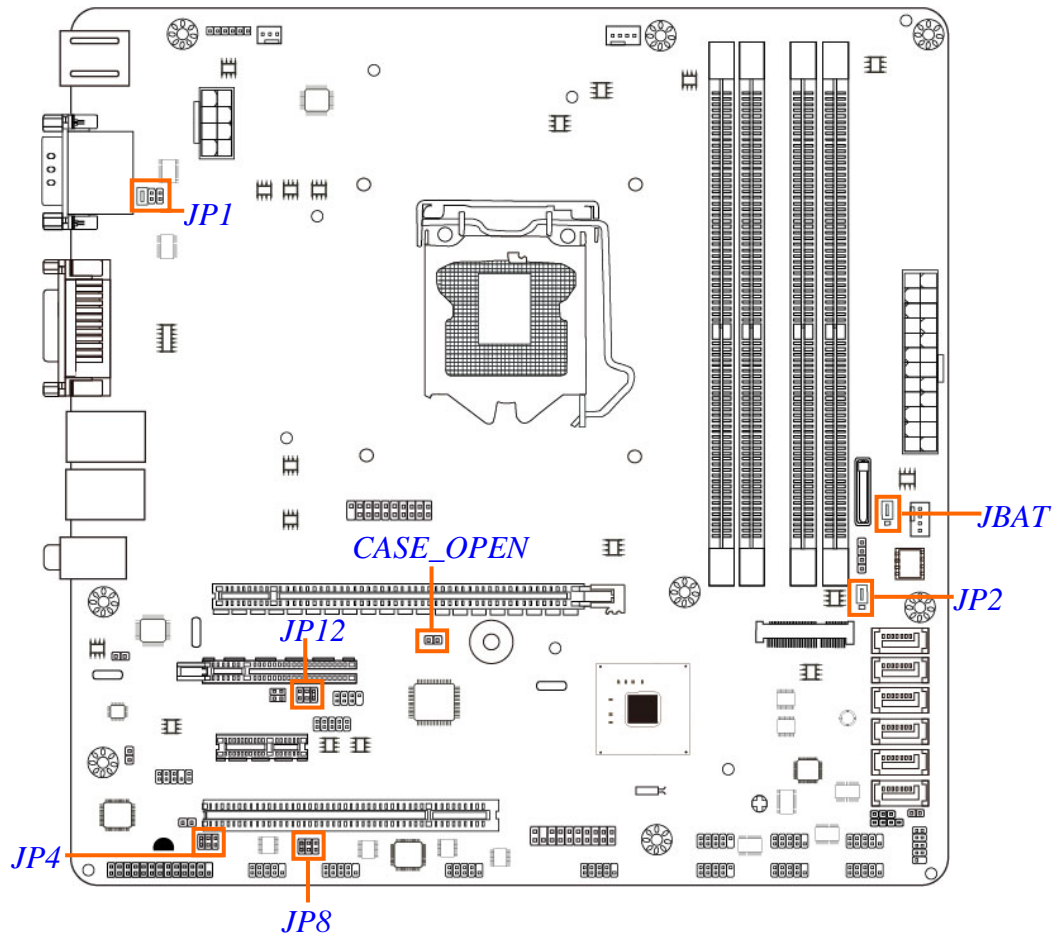

Jumper

Jumper	Name	Description
JBAT	CMOS RAM Clear Function Setting	3-pin Block
JP1	COM1 Ports Pin9 Function Select	6-pin Block
JP2	Mini PCI-E Power VCC3.3V/3.3VSB Select	3-pin Block
JP4	COM3 Header Pin9 Function Select	6-pin Block
JP12	COM3 Header RS232/485/422 Function Select	6-pin Block
JP8	COM4 Header Pin9 Function Select	6-pin Block
Case_open	Case Open Message Display Function Select	2-pin Block

Connectors

Connector	Name
ATXPWR	ATX Power Connector
ATX12V1	ATX 12V Power Connector
USB4	USB 3.0 Connector X2
HDMI	High-Definition Multimedia Interface
VGA	Video Graphic Attach Connector
DVI	DVI-D Port Connector
COM1(Top)/COM2(Bottom)	Serial Port COM Connector X2
UL1(Middle & Bottom)/UL2(Middle & Bottom)	USB 2.0 Port Connector X4
UL1(Top)/UL2(Top)	RJ-45 LAN Connector X2
AUDIO1	Audio Connector X3
SATA1/SATA2	SATAIII Connector X2
SATA3/SATA4/SATA5/SATA6	SATAII Connectors X4

Headers

Header	Name	Description
FP_AUDIO	Front panel audio Header	9-pin block
HDMI_SPDIF	HDMI_SPDIF Out Header	2-pin Block
KBMS	PS/2 Keyboard & Mouse Header	6-pin Block
SPEAK	Speaker Header	4-pin Block
PWRLED	Power LED	3-pin Block
JW_FP (Front Panel Header)	PWR LED/ HDD LED/ /Power Button /Reset	9-pin Block
CIR	CIR Header	7-pin Block
USB1	USB 3.0 Header	19-pin Block
USB2/USB3	USB 2.0 Header	9-pin Block
COM 3/4/5/6/7/8/9/10	Serial Port Header	9-pin Block
TX-RXCOM	RS 422/485 port header	4-pin block
GPIO_CON	GPIO Header	10-pin Block
TPM	TPM Header	19-pin Block
PARALLEL	Parallel Port Header	25-pin Block
LAN1LED/LAN2LED	LANLED Header	2-pin Block
SM_BUS	SMBUS Header	4-pin Block
SYSFAN1	SYSFAN1 Header	3-pin Block
SYSFAN2/CPUFAN	FAN Header	4-pin Block

Chapter 2

Hardware Installation

2-1 Jumper Setting

(1) JBAT (3-pin): Clear CMOS

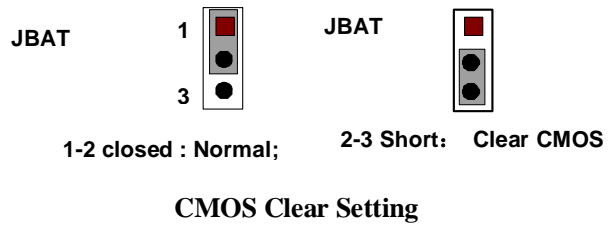
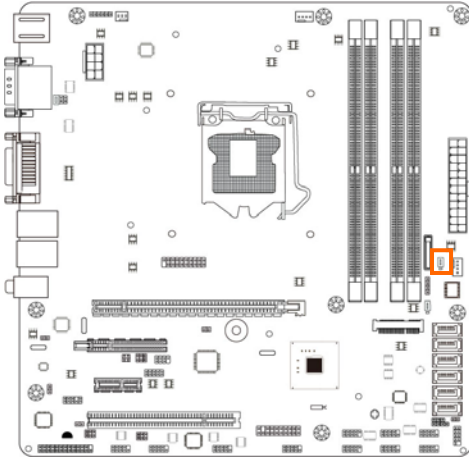

(2) JP1 (6-pin): COM1 Ports Pin9 Function Select

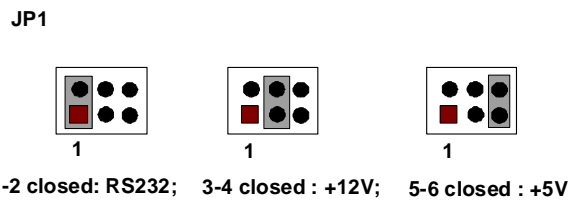
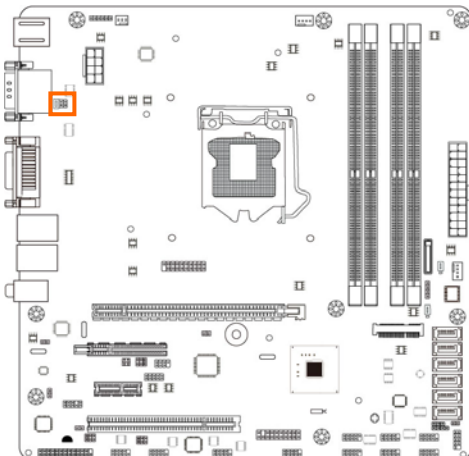

(3) JP2 (3-pin): Mini PCI-E Power VCC 3.3V/3.3 VSB Select

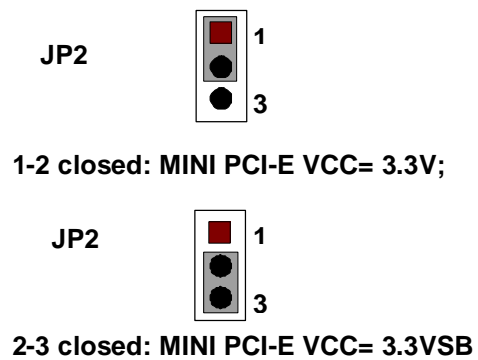
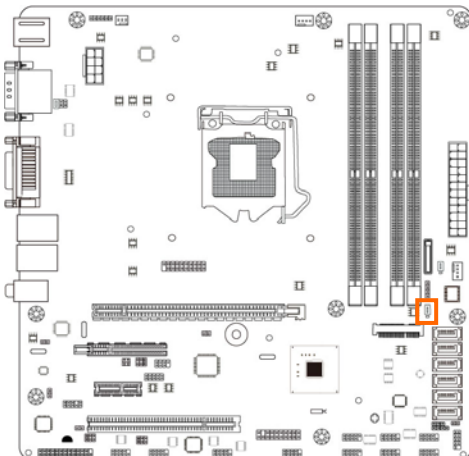

(4) JP4 (6-pin): COM3 Port Pin9 Function Select

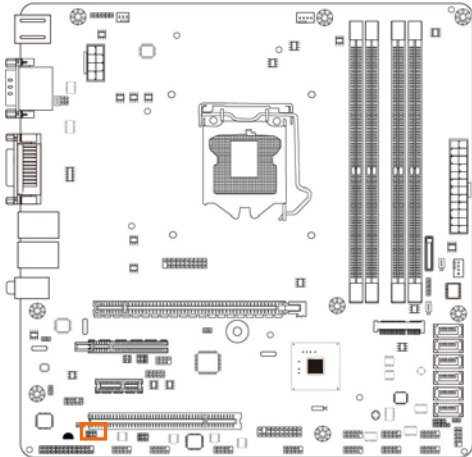

JP4



1



1



1

1-2 closed: RS232; 3-4 closed : +12V; 5-6 closed : +5V

(5) JP12 (6-pin): COM3 Header RS232/485/422 Function Select

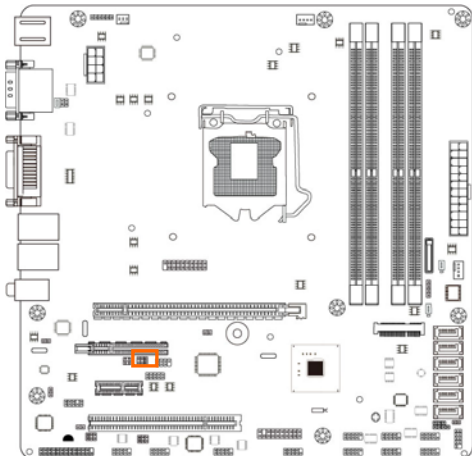

JP12



1



1



1

1-2 closed: RS232; 3-4 closed : RS485; 5-6 closed : RS422

(6) JP8 (6-pin): COM4 Port Pin9 Function Select

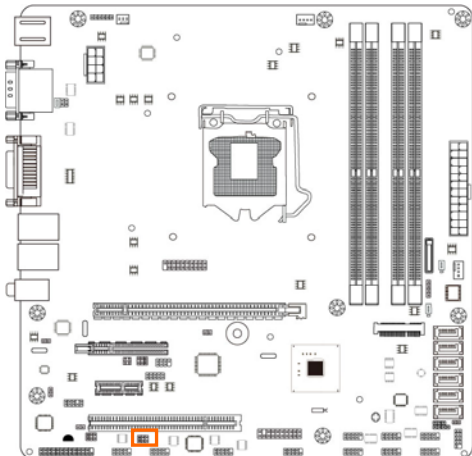

JP8



1



1



1

1-2 closed: RS232; 3-4 closed : +12V; 5-6 closed : +5V

(7) CASE_OPEN (2-pin): Case Open Message Display Function Select

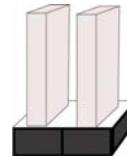
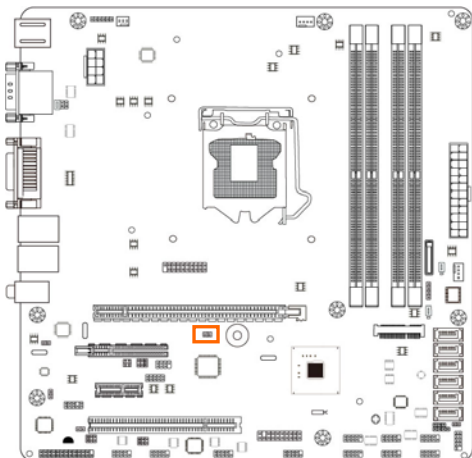

Pin 1-2 shorted: Case open display function enabled. Use needs to enter BIOS and enable 'Case Open Detect' function. In this case if you case is removed, next time when you restart your computer a message will be displayed onscreen to inform you of this.

2-2 Connectors and Headers

2-2-1 Rear I/O Back Panel Connectors

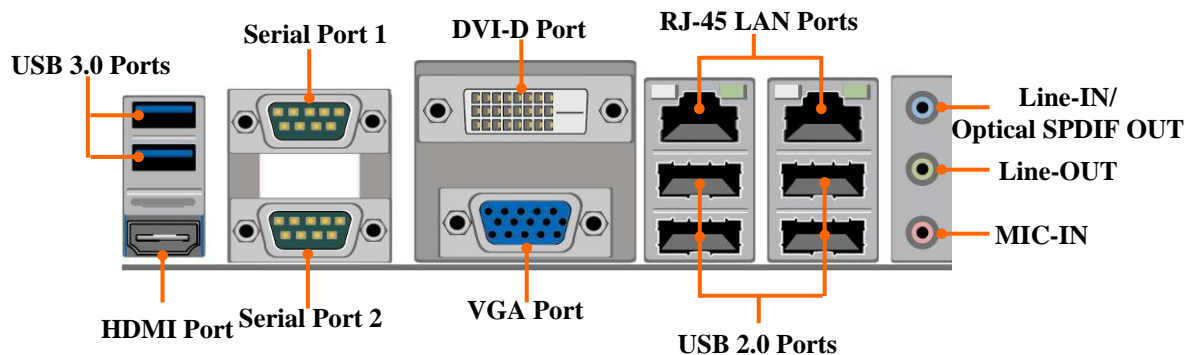

(1) USB 3.0 Port Connector: USB4

These USB 3.0 connectors are for user to connect USB 3.0 compatible devices to the system board.

(2) D-Sub 15-pin Connector: VGA

VGA connector is the 15-pin D-subminiature female connector; it is for the display devices, such as the CRT monitor, LCD monitor and so on.

(3) Digital Visual Interface: DVI

This interface standard designed to maximize the visual quality of digital display devices such as flat panel LCD computer displays and digital projectors.

(4) High-Definition Multimedia Interface: HDMI

This point-to-point interface is for audio and video signals designed as a single-cable solution for home theater and consumer electronics equipment.

NOTE! DVI and HDMI Connector can not be used at the same time.

(5) USB 2.0 Port Connector: UL1(Middle & Bottom)/ UL2(Middle & Bottom)

These USB 2.0 connectors are for user to connect USB 2.0 compatible devices to the system board.

(6) RJ-45 LAN Port Connectors: UL1(Top)/UL2(Top)

The connectors are standard RJ-45 connectors for Network.

(7) Serial Port Connector: COM1 (Top)/COM2(bottom)

These two serial ports are for user to connect compatible mouse, modem or other peripherals.

(8) Audio Line-In, Lin-Out connector: AUDIO1

These Connectors are 3 Phone-Jack for LINE-OUT, LINE-IN, MIC audio connections.

- Line-in: (BLUE)** Audio input to sound chip
- Line-out: (GREEN)** Audio output to speaker
- MIC: (PINK)** Microphone Connector

2-2-2 Motherboard Internal Connectors

(1) Power Connector (24-pin block): AXPWR

ATX Power Supply connector: This is a new defined 24-pins connector that usually comes with ATX case. The ATX Power Supply allows using soft power on momentary switch that connect from the front panel switch to 2-pins Power On jumper pole on the motherboard. When the power switch on the back of the ATX power supply turned on, the full power will not come into the system board until the front panel switch is momentarily pressed. Press this switch again will turn off the power to the system board.

- ** We recommend that you use an ATX 12V Specification 2.0-compliant power supply unit (PSU) with a minimum of 350W power rating. This type has 24-pin and 4-pin power plugs.
- ** If you intend to use a PSU with 20-pin and 4-pin power plugs, make sure that the 20-pin power plug can provide at least 15A on +12V and the power supply unit has a minimum power rating of 350W. The system may become unstable or may not boot up if the power is inadequate.
- ** If you are using a 20-pin power plug, please refer to Figure1 for power supply connection. Power plug form power supply and power connectors from motherboard both adopt key design to avoid mistake installation. You can insert the power plug into the connector with ease only in the right direction. If the direction is wrong it is hard to fit in and if you make the connection by force it is possible.

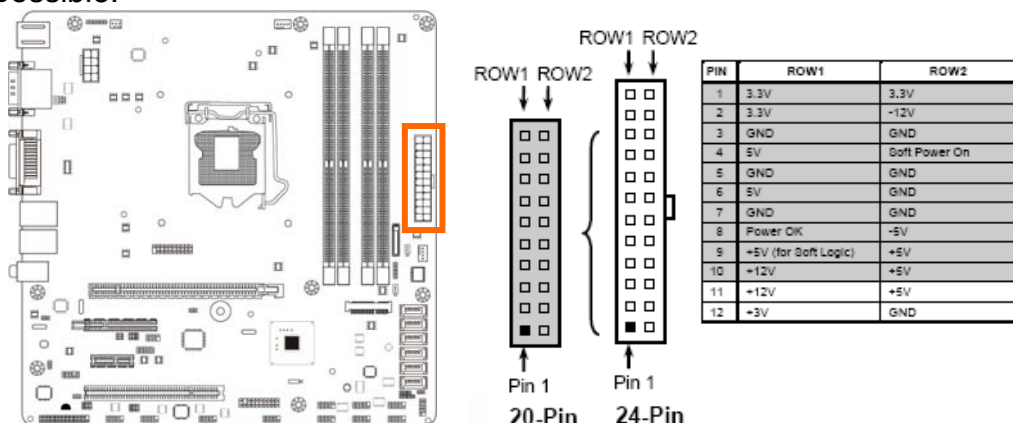

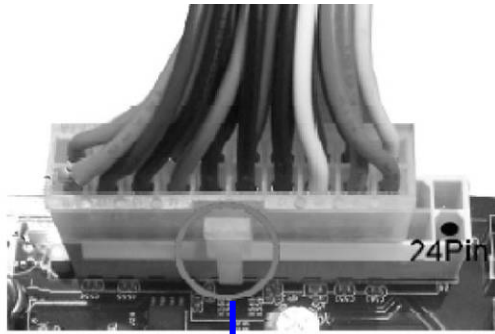

Figure1: 20-pin power plug

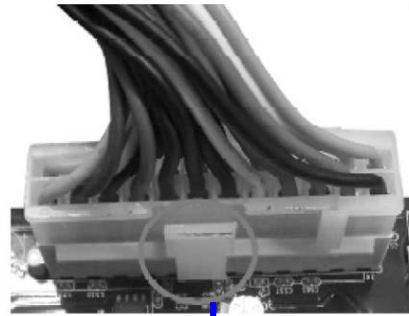
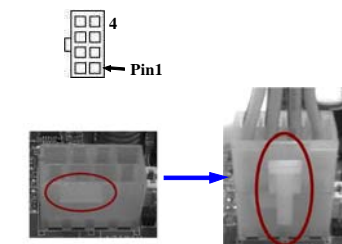
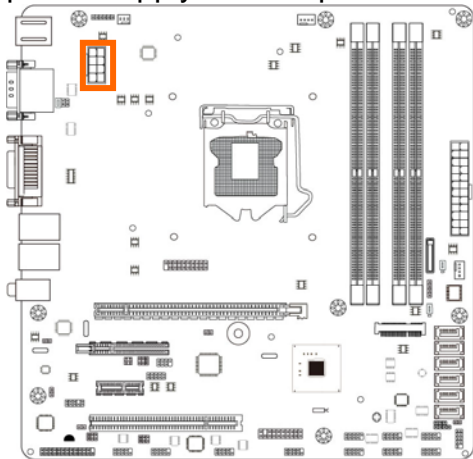

Figure 2: 24-pin power plug

(2) ATX 12V Power Connector (8-pin block): ATX12V

This is a new defined 8-pin connector that usually comes with ATX Power Supply. The ATX Power Supply which fully supports AMD AM3 processor must including this connector for support extra 12V voltage to maintain system power consumption. Without this connector might cause system unstable because the power supply can not provide sufficient current for system.



Pin	Definition	No.	Definition
1	GND	5	+12V
2	GND	6	+12V
3	GND	7	+12V
4	GND	8	+12V

(3) SATAIII Port connector: SATA1/SATA2

These connectors are high-speed SATAIII ports that support 6 GB/s transfer rate.

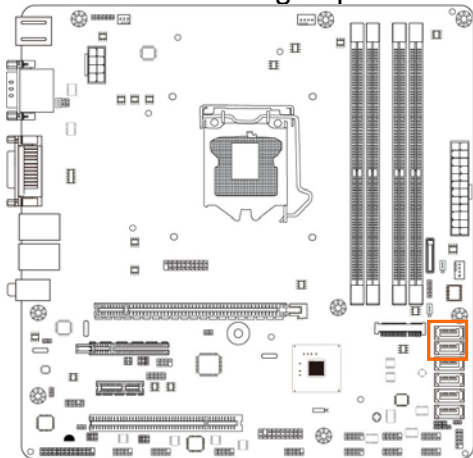

Pin No.	Defnition
1	GND
2	TXP
3	TXN
4	GND
5	RXN
6	RXP
7	GND

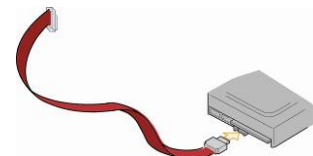

(4) SATAII Port connector: SATA3/SATA4/SATA5/SATA6

These connectors are high-speed SATAII ports that support 3 GB/s transfer rate.

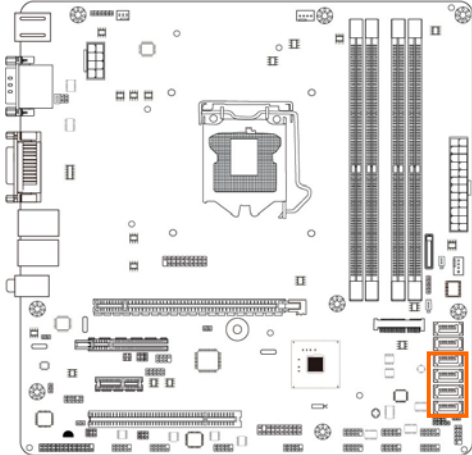

Pin No.	Definition
1	GND
2	TXP
3	TXN
4	GND
5	RXN
6	RXP
7	GND

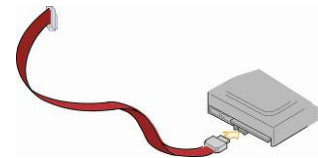

2-2-3 Header Pin Definition

(1) FP_AUDIO (9-pin): Line-Out, MIC-In Header

This header is connected to Front Panel Line-out, MIC connector with cable.

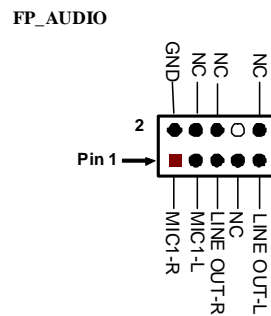
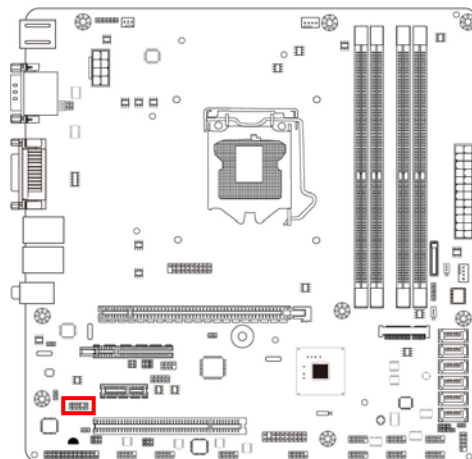

Line-Out, MIC Header

(2) HDMI_SPDIF (2-pin): HDMI-SPDIF Out header

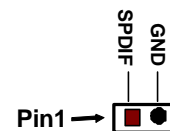
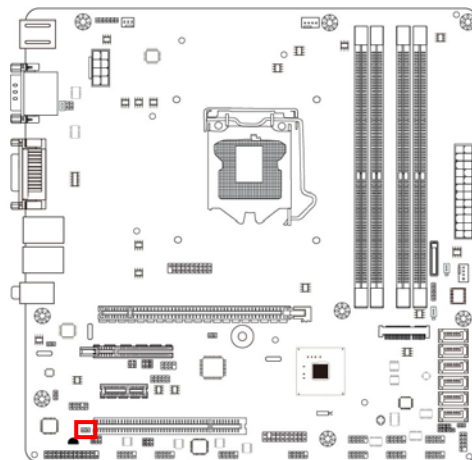

HDMI_SPDIF Header

(3) KBMS (6-pin): PS/2 Keyboard & Mouse Header

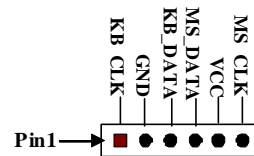
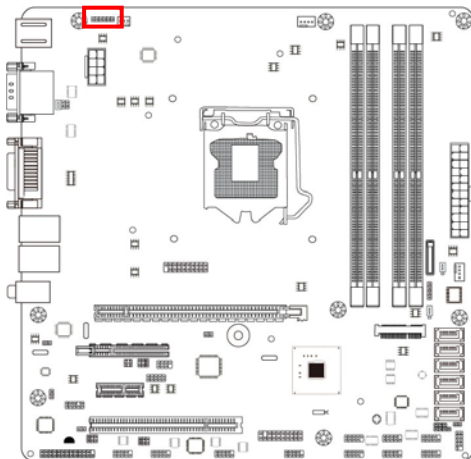

(4) SPEAK (4-pin): Speaker Header

This 4-pin header connects to the case-mounted speaker. See the figure below.

(5) PWR LED(3-pin): PWR LED Header

The Power LED is light on while the system power is on. Connect the Power LED from the system case to this pin header.

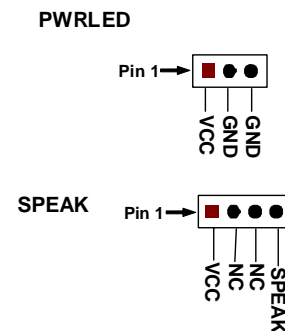
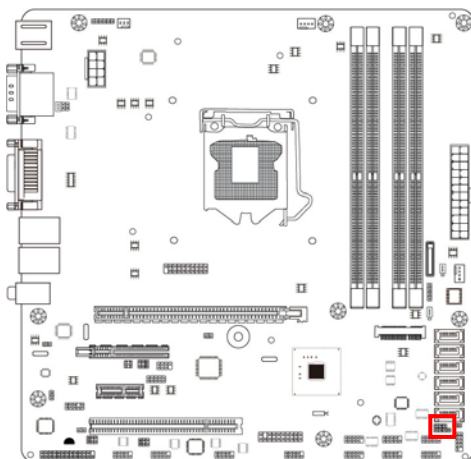

(6) JW-FP (9-pin): Front Panel Header

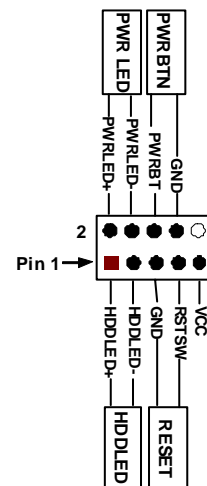
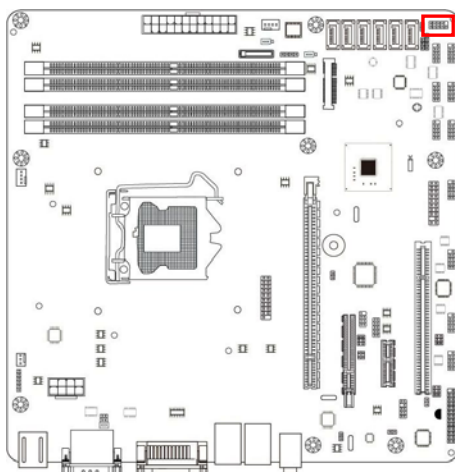

(7) CIR (7-Pin): CIR Header

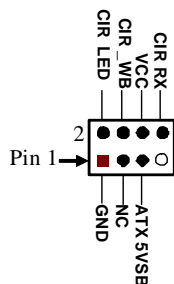
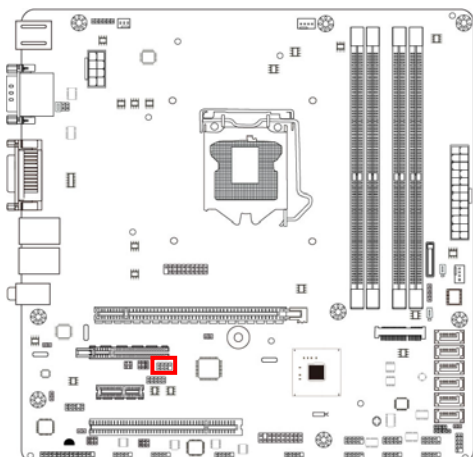

CIR Header

(8) USB 3.0 Port Header (19-pin): USB1

This USB 3.0 header is used for connecting the additional USB 3.0 port plugs. By attaching an optional USB 3.0 cable, you can be provided with two additional USB 3.0 plugs affixed to the back panel.

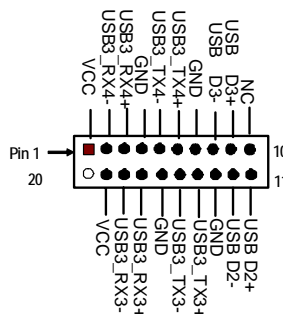
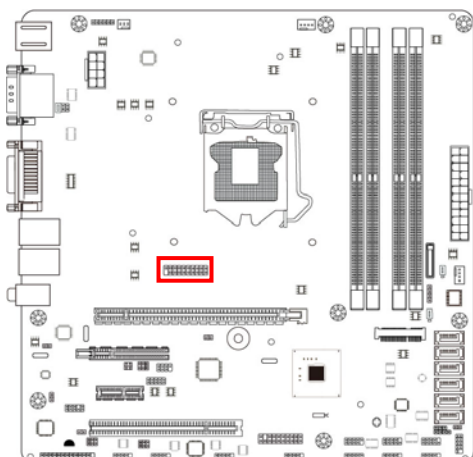

(9) USB 2.0 Port Headers (9-pin): USB2/USB3

These headers are used for connecting the additional USB 2.0 port plugs. By attaching an option USB cable, you can be provided with two additional USB 2.0 plugs affixed to the back panel.

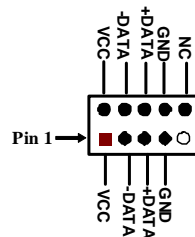
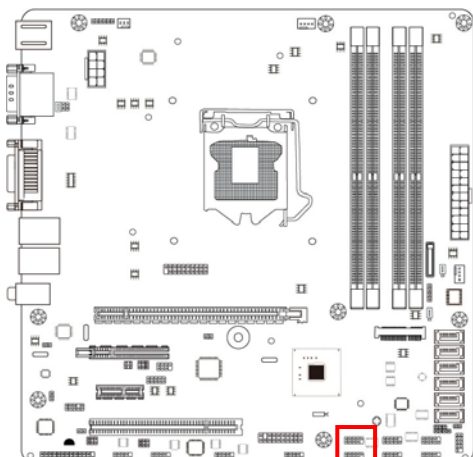

(10) COM3/4/5/6/7/8/9/10 (9-Pin): Serial Port Header

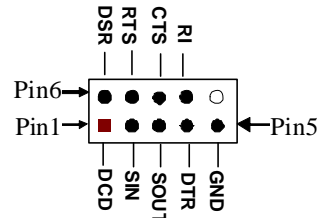
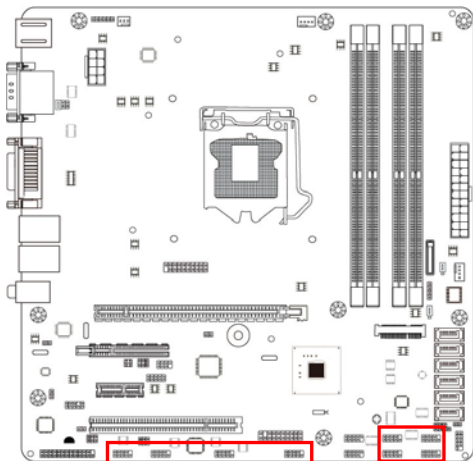

(11) TX-RXCOM (4-pin): RS422/485 Header

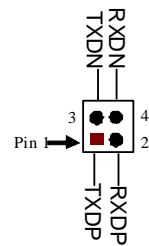
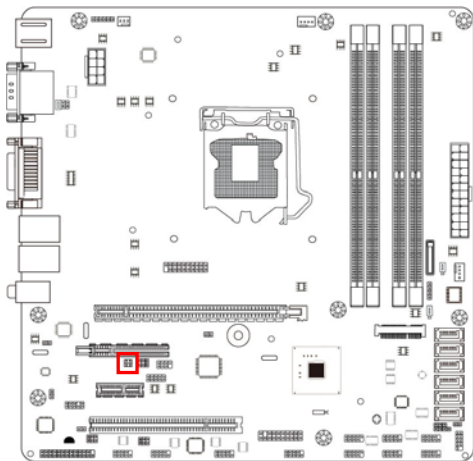

(12) GPIO_CON (10-pin): GPIO Header

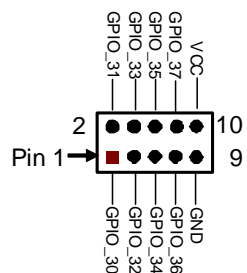
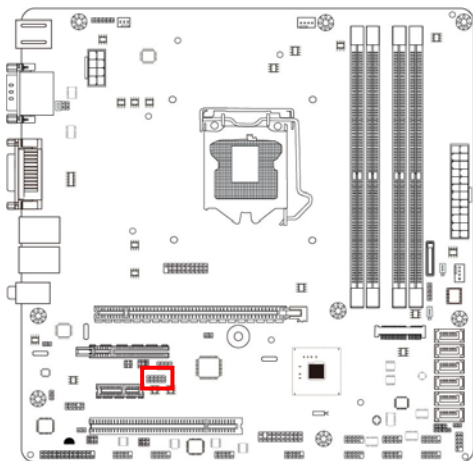

(13) TPM (19-pin): TPM Header

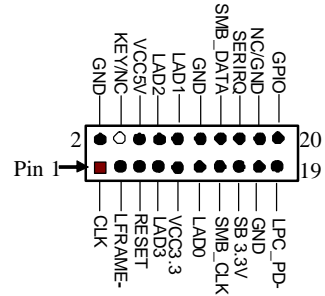
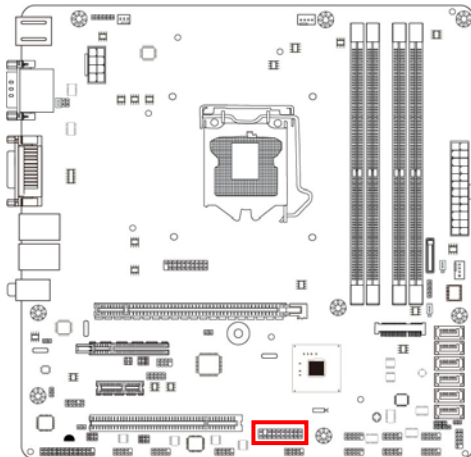

(14) PARALLEL (25-pin): Parallel Port Header

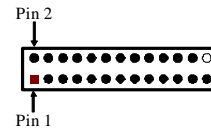
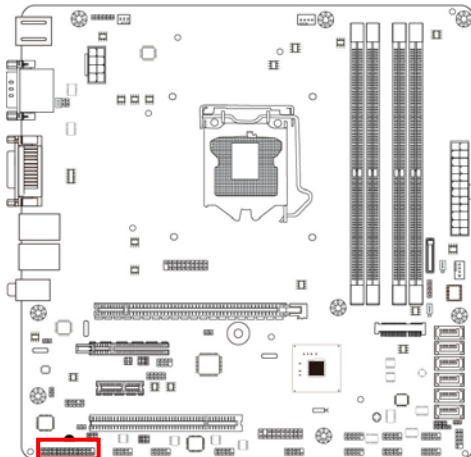

Parallel Header

Pin NO.	Pin Definition	Pin NO.	Pin Definition
Pin 1	STB-	Pin 2	AFD-
Pin 3	PD0	Pin 4	ERR-
Pin 5	PD1	Pin 6	INIT-
Pin 7	PD2	Pin 8	SLIN-
Pin 9	PD3	Pin 10	GND
Pin 11	PD4	Pin 12	GND
Pin 13	PD5	Pin 14	GND
Pin 15	PD6	Pin 16	GND
Pin 17	PD7	Pin 18	GND
Pin 19	ACK-	Pin 20	GND
Pin 21	BUSY	Pin 22	GND
Pin 23	PE	Pin 24	GND
Pin 25	SLCT	Pin 26	No Key

(15) LAN1LED/LAN2LED (2-pin): LANLED Header

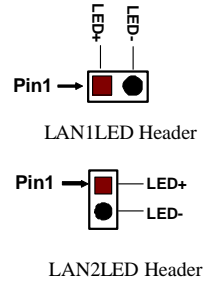
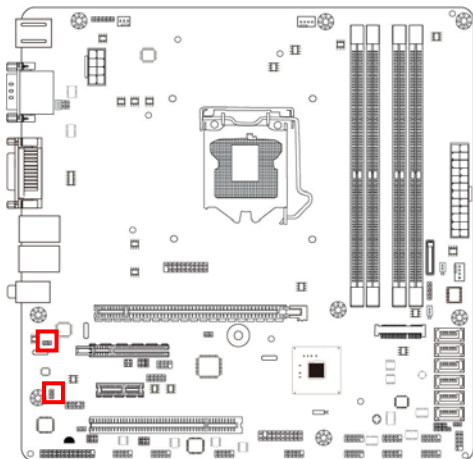

(16) SM_BUS (4-pin): SM BUS Header

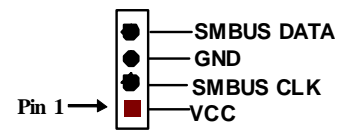
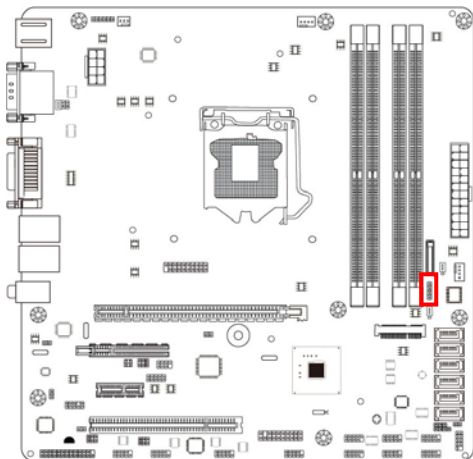

(17) SYSFAN1 (3-pin), SYSFAN2 (4-pin), CPUFAN (4-pin): FAN Headers

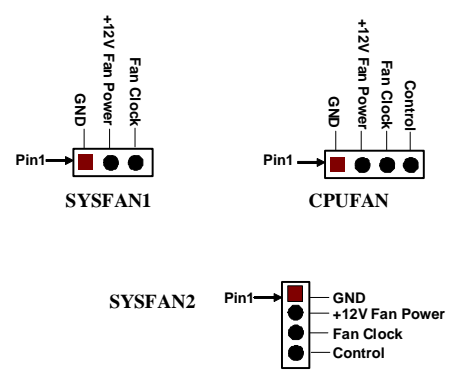
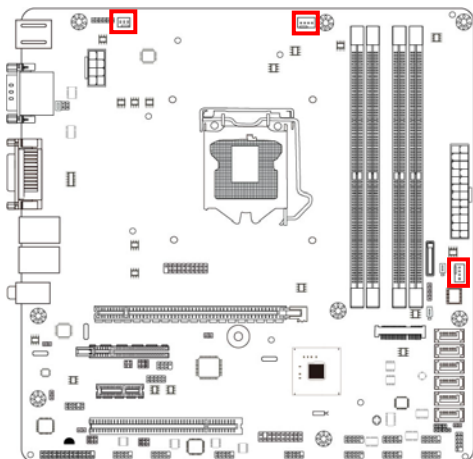

Chapter 3

Introducing BIOS

Notice! The BIOS options in this manual are for reference only. Different configurations may lead to difference in BIOS screen and BIOS screens in manuals are usually the first BIOS version when the board is released and may be different from your purchased motherboard. Users are welcome to download the latest BIOS version form our official website.

The BIOS is a program located on a Flash Memory on the motherboard. This program is a bridge between motherboard and operating system. When you start the computer, the BIOS program will gain control. The BIOS first operates an auto-diagnostic test called POST (power on self test) for all the necessary hardware, it detects the entire hardware device and configures the parameters of the hardware synchronization. Only when these tasks are completed done it gives up control of the computer to operating system (OS). Since the BIOS is the only channel for hardware and software to communicate, it is the key factor for system stability, and in ensuring that your system performance as its best.

3-1 Entering Setup

Power on the computer and by pressing immediately allows you to enter Setup. If the message disappears before your respond and you still wish to enter Setup, restart the system to try again by turning it OFF then ON or pressing the "RESET" button on the system case. You may also restart by simultaneously pressing <Ctrl>, <Alt> and <Delete> keys. If you do not press the keys at the correct time and the system does not boot, an error message will be displayed and you will again be asked to

Press to enter Setup

3-2 BIOS Menu Screen

The following diagram show a general BIOS menu screen:

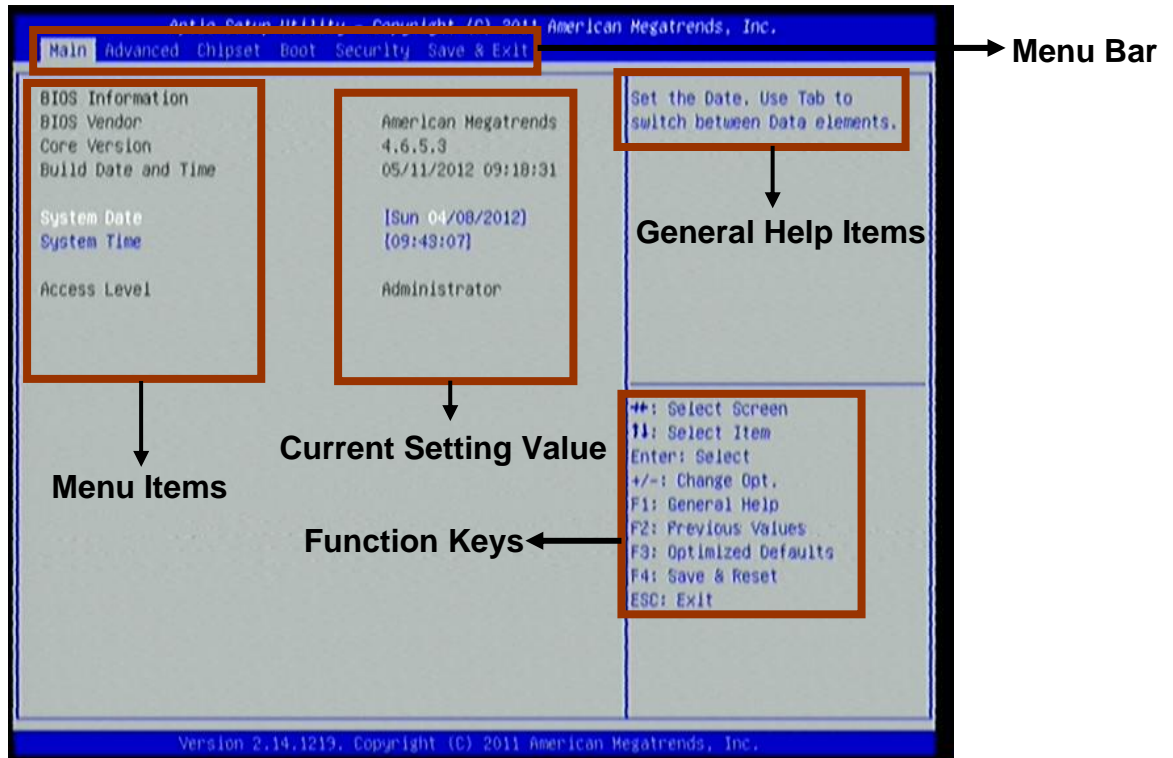

BIOS Menu Screen

3-3 Function Keys

In the above BIOS Setup main menu of, you can see several options. We will explain these options step by step in the following pages of this chapter, but let us first see a short description of the function keys you may use here:

- Press ←→ (left, right) to select screen;
- Press ↑↓ (up, down) to choose, in the main menu, the option you want to confirm or to modify.
- Press <Enter> to select.
- Press <+>/<-> keys when you want to modify the BIOS parameters for the active option.
- [F1]: General help.
- [F2]: Previous value.
- [F3]: Optimized defaults.
- [F4]: Save & Reset.
- Press <Esc> to quit the BIOS Setup.

3-4 Getting Help

Main Menu

The on-line description of the highlighted setup function is displayed at the top right corner the screen.

Status Page Setup Menu/Option Page Setup Menu

Press F1 to pop up a small help window that describes the appropriate keys to use and the possible selections for the highlighted item. To exit the Help Window, press <Esc>.

3-5 Menu Bars

There are six menu bars on top of BIOS screen:

Main	To change system basic configuration
Advanced	To change system advanced configuration
Chipset	To change chipset configuration
Boot	To change boot settings
Security	Password settings
Save & Exit	Save setting, loading and exit options.

User can press the right or left arrow key on the keyboard to switch from menu bar. The selected one is highlighted.

3-6 Main Menu

Main menu screen includes some basic system information. Highlight the item and then use the <+> or <-> and numerical keyboard keys to select the value you want in each item.

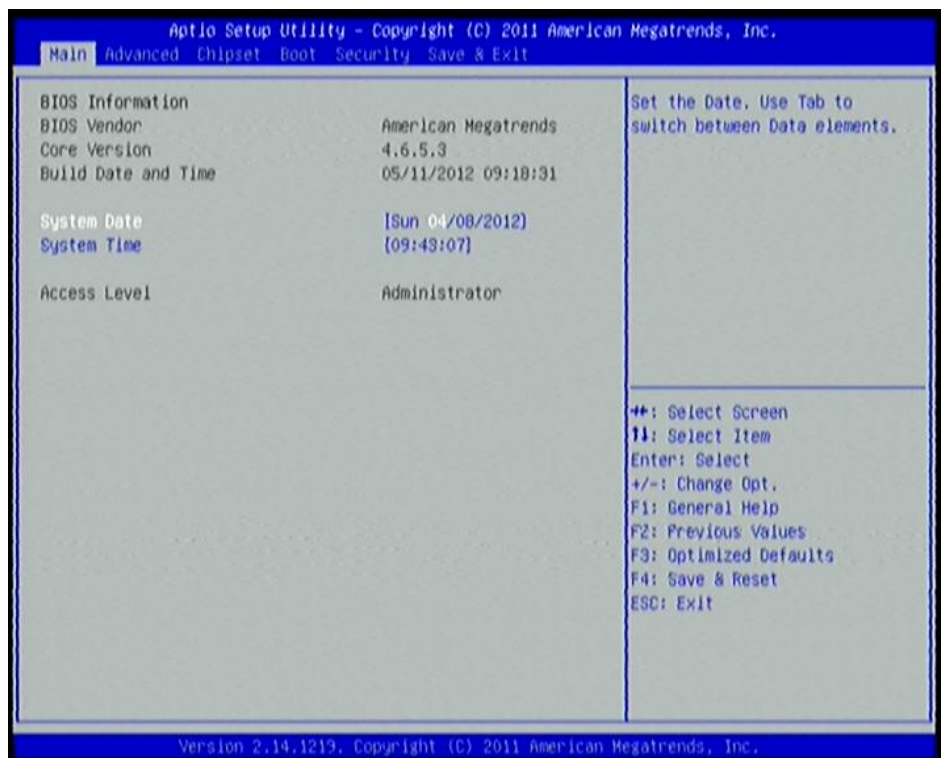

System Date

Set the date. Please use [Tab] to switch between data elements.

System Time

Set the time. Please use [Tab] to switch between time elements.

3-7 Advanced Menu

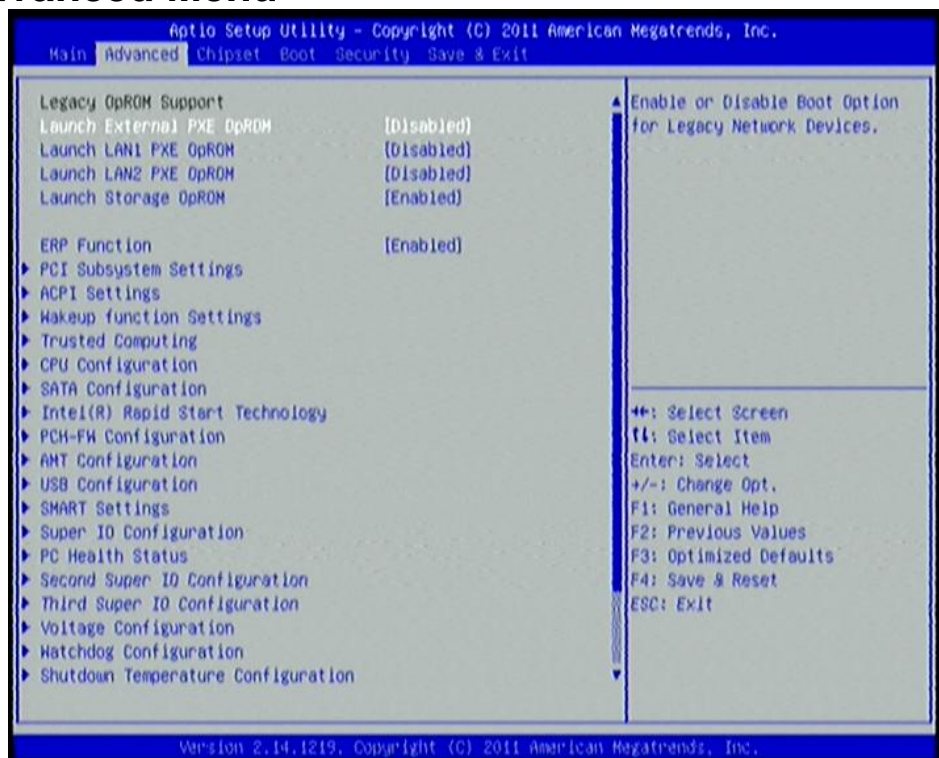

Scroll down to view more setting options:



Legacy OpROM Support

Launch External PXE OpROM/Launch LAN1 PXE OpROM/Launch LAN2 PXE OpROM

Use this item to enable or disable boot option for legacy network devices.

Launch Storage OpROM

Use this item to enable or disable boot options for legacy mass storage devices with option ROM.

ERP Function

Use this item to enable or disable ERP function for this board. This item should be set as [Disabled] if you wish to have Active All Wakeup Function.

PCI Subsystem Settings

Press [Enter] to enter and make settings for the following sub-items:

PCI 64bit Resources Handing:

Above 4G Decoding

Use this item to enable or disable 64bit capable devices to be decoded in above 4G address space (only if system support 64 bit PCI decoding).

PCI Common Settings:

PCI Latency Timer

Use this item to set value to be programmed into PCI latency timer register.

VGA Palette Snoop

Use this item to enable or disable VGA palette registers snooping.

PERR# Generation

Use this item to enable or disable PCI device to generate PERR#.

SERR# Generation

Use this item to enable or disable PCI device to generate SERR#.

PCI Express Settings

Press [Enter] to make settings for the following sub-items:

PCI Express Device Register Settings:

Relaxed Ordering

Use this item to enable or disable PCI express device relaxed ordering.

Extended Tag

If set as [Enabled] it will allow device to use 8-bit tag field as a requester.

No Snoop

Use this item to enable or disable PCI Express device No Snoop option.

Maximum Payload

Use this item to set maximum payload of PCI Express device or allow system BIOS to select the value.

Maximum Read Request

Use this item to set maximum read request size of PCI Express device or allow system BIOS to select the value.

PCI Express Link Register Settings:

ASPM Support

The optional settings: [Disabled]; [Auto]; [Force L0s].

Extended Synch

If set as [Enabled] it will allow generation of extended synchronization patterns.

Link Training Retry

Use this item to define number of retry attempts software will take to retrain the link if previous training attempt was unsuccessful.

Link Training Timeout(uS)

Use this item to define number of microseconds software will wait before polling 'Link Training' bit in link status register. Value range from 10 to 1000 uS.

Unpopulated Links

The optional settings are: [Keep Link On]; [Disable Link]. In order to save power, software will disable unpopulated PCI Express links if this option is set as 'Disable Link'.

ACPI Settings

Press [Enter] to make settings for the following sub-items:

ACPI Settings:

ACPI Sleep State

Use this item to select the highest ACPI sleep state the system will enter when the suspend button is pressed.

S3 Video Repost

Use this item to enable or disable S3 video report.

Wakeup Function Settings

Press [Enter] to make settings for the following sub-items:

Wake System with Fixed Time

Use this item to enable or disable system wake on alarm event. When set as [Enabled], system will wake on the hour/min/sec specified.

CIR Wakeup

Use this item to enable or disable CIR wakeup.

PS2 KB/MS Wakeup

Use this item to enable or disable PS2 KB/MS wakeup. This function is only supported when ERP function is disabled.

PCI PME Wakeup

Use this item to enable or disable S3/S4/S5 PCI PME Wakeup. This function is only supported when ERP function is disabled.

USB S3/S4 Wakeup

Use this item to enable or disable USB S3/S4 wakeup. This function is only supported when ERP function is disabled.

Trusted Computing

Press [Enter] to enable or disable TPM support.

CPU Configuration

Press [Enter] to make settings for the following sub-items:

Hyper-Threading

The optional settings are: [Disabled]; [Enhanced].

Active Processor Cores

Use this item to select number of cores to enable in each processor package.

Limit CPUID Maximum

The optional settings are: [Disabled]; [Enhanced]. This item should be set as [Disabled] for Windows XP.

Execute Disable Bit

The optional settings are: [Disabled]; [Enhanced].

Intel Virtualization Technology

The optional settings: [Enabled]; [Disabled].

When set as [Enabled], a VHM can utilize the additional hardware capabilities provided by Vanderpool Technology.

Hardware Prefetcher

Use this item to turn on/off the Mid Level Cache (L2) streamer prefetcher.

Adjacent Cache Line Prefetch

Use this item to turn on/off prefetching of adjacent cache lines.

SATA Configuration

Press [Enter] to make settings for the following sub-items:

SATA Controller(s)

The optional settings are: [Disabled]; [Enhanced].

SATA Mode Selection

The optional settings are: [IDE]; [AHCI]; [RAID].

Intel(R) Rapid Start Technology

Use this item to enable or disable Intel(R) Rapid Start Technology

PCH-FW Configuration

Press [Enter] to see ME information and make settings for Firmware Update Configuration.

Firmware Update Configuration

Press [Enter] to make settings for ME FW Image RE-Flash.

ME FW Image RE-Flash

Use this item to enable or disable ME FW Image Re-Flash function.

AMT Configuration

Use this item to configure Active Management Technology parameters.

Press [Enter] to make settings for the following sub-items:

Intel AMT

Use this item to enable or disable Intel Active Management Technology.

BIOS Hotkey Pressed

The optional settings are: [Disabled]; [Enabled].

MEBx Selection Screen

The optional settings are: [Disabled]; [Enabled].

Hide Un-Configure ME Confirmation

Use this item to hide Un-Configure ME without password confirmation prompt. The optional settings are: [Disabled]; [Enabled].

MEBx Debug Message Output

The optional settings are: [Disabled]; [Enabled].

Un-Configure ME

The optional settings are: [Disabled]; [Enabled].

Amt Wait Timer

Use this item to set time to wait before sending ASF_GET_BOOT_OPTIONS.

Disable ME

The optional settings are: [Disabled]; [Enabled].

ASF

Use this item to enable or disable alert specification format.

Active Remote Assistance Process

The optional settings are: [Disabled]; [Enabled].

USB Configure

Use this item to enable or disable USB configure function.

PET Progress

Use this item to enable or disable PET events progress to receive PET event or not.

USB Configuration

Press [Enter] to make settings for the following sub-items:

Legacy USB Support

The optional settings are: [Auto]; [Disabled]; [Enabled].

EHCI Hand-off

The optional settings are: [Disabled]; [Enabled].

USB hardware delay and time-out:

USB Transfer time-out

Use this item to set the time-out value for control, bulk, and interrupt transfers.

Device reset time-out

Use this item to set USB mass storage device start unit command time-out.

Device power-up delay

Use this item to set maximum time the device will take before it properly reports itself to the host controller. 'Auto' uses default value: for a root port it is 100 ms, for a hub port the delay is taken from hub descriptor. The optional settings: [Auto]; [Manual]. Select [Manual] you can set value for the following sub-item: **Device Power-up delay in seconds**, the delay range in from 1 to 40 seconds, in one second increments.

SMART Settings

Press [Enter] to make settings for SMART Self Test. The optional settings are: [Disabled]; [Enabled].

Super I/O Configuration

Press [Enter] to make settings for the following sub-items:

Super IO Configuration

COM1 Port Configuration/ COM2 Port Configuration

Press [Enter] to make settings for the following items:

Serial Port

Use this item to enable or disable serial port (COM).

Change Settings

Use this item to select an optimal setting for super IO device.

Parallel Port Configuration

Parallel port

Use this item to enable or disable Parallel port (LPT/LPTE)

Change Settings

Use this item to select an optimal setting for super IO device.

Device Mode

Use this item to change the Printer Port.

CIR Controller

Use this item to enable or disable CIR controller.

Case Open Detect

Use this item to detect case has already open or not, show message in POST.

PC Health Status

Press [Enter] to view hardware health status.

Second Super IO Configuration

COM3 Port Configuration /COM4 Port Configuration / COM5 Port Configuration /COM6 Port Configuration

Serial Port

Use this item to enable or Disable serial port (COM).

Change Settings

Use this item to select an optimal setting for super IO device.

Serial Port Mode Select

Use this item to set serial port as [RS232] or [RS422/485].

**Note: Serial Port Mode Select function is only optional for COM3 port.*

Third Super IO Configuration

COM7 Port Configuration /COM8 Port Configuration/COM9 Port Configuration /COM10 Port Configuration

Serial Port

Use this item to enable or Disable serial port (COM1).

Change Settings

Use this item to select an optimal setting for super IO device.

Voltage Configuration

Use this item to choose the Voltage Parameters. Press [Enter] user can set a specific value for **AXG Voltage** from available options.

WatchDog Configuration

Press [Enter] to make settings for Watchdog Configuration:

Watchdog Configuration:

WatchDog Timer Control

Use this item to enable or disable WatchDog Timer Control. When set as [Enabled], the following sub-items shall appear:

WatchDog Timer Val

User can set a value in the range of 4 to 255.

WatchDog Timer Unit

The optional settings are: [Second];[Minute].

Shutdown Temperature Configuration

Use this item to select system shutdown temperature.

CPU PPM Configuration

Press [Enter] to make settings for CPU PPM Configuration:

CPU PPM Configuration:

EIST

Use this item to enable or disable Intel SpeedStep.

CPU C3 Report

Use this item to enable or disable CPU C3 (ACPI C2) report to OS.

CPU C6 Report

Use this item to enable or disable CPU C6 (ACPI C3) report to OS.

SmartFan Configuration

Press [Enter] to make settings for SmartFan Configuration:

CPUFAN / SYSFAN1/ SYSFAN2 Smart Mode

When set as [Enabled], the following sub-items shall appear:

CPUFAN / SYSFAN1/ SYSFAN2 Full Speed Temp

Use this item to set CPUFAN/SYSFAN1/SYSFAN2 full speed temp. Fan will run at full speed when above this temperature.

CPUFAN / SYSFAN1/ SYSFAN2 Idle Temp

Use this item to set CPUFAN/SYSFAN1/SYSFAN2 idle speed temperature. Fan will run at idle speed when below this temperature.

SYSFAN1/ SYSFAN2 Stop Temp

Use this item to set SYSFAN1/SYSFAN2 stop temp. Fan will stop when below this temperature.

SYSFAN2 3/4 Pin Fan Select

The optional settings are: [3 pin]/ [4 pin Fan].

3-8 Chipset Menu

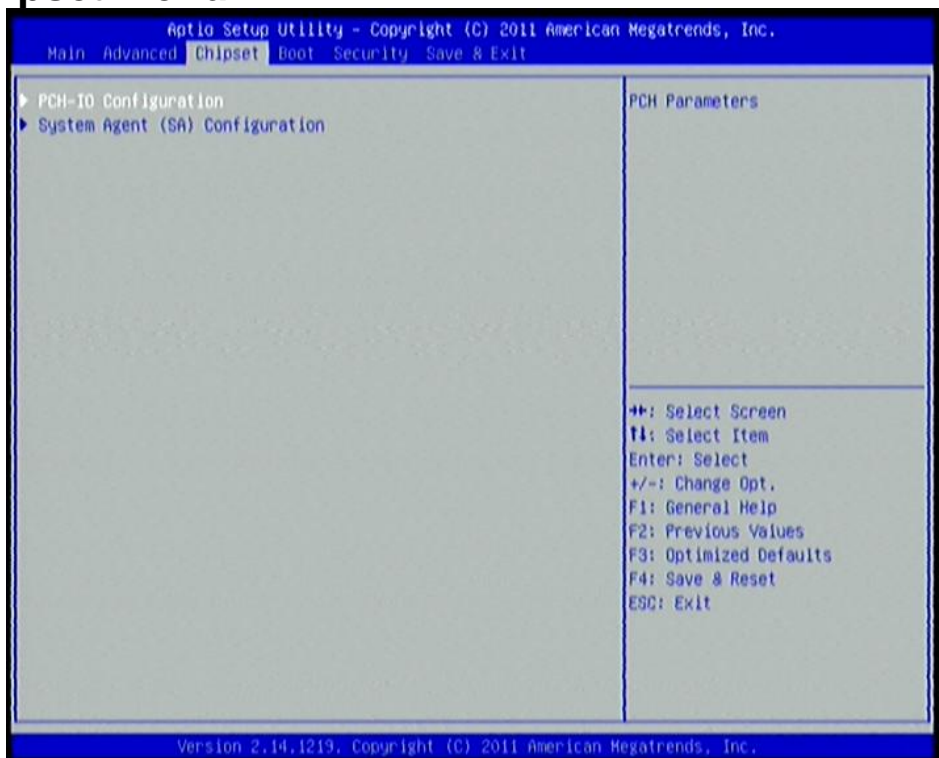

PCH-IO Configuration

Press [Enter] to make settings for the following sub-items:

USB Devices Configuration

Press [Enter] to further setting USB device configuration.

USB Device Configuration:

XHCI Pre-Boot Driver

Use this item to enable or disable XHCI Pre-Boot Driver Support.

XHCI Mode

The optional settings are: [Smart Auto]; [Auto]; [Enabled];[Disabled].

HS Port #1 Switchable/ HS Port #2 Switchable/HS Port #3 Switchable/HS Port #4 Switchable

The optional settings are: [Disabled]; [Enabled].These items allow for HS port switching between XHCI and EHCI. If set as [Disabled], port is routed to EHCI.

***Note:** The above items shall not appear when **XHCI Mode** is set as [Disabled].

XHCI Streams

The optional settings are: [Disabled]; [Enabled]. Use this item to enable or disable XHCI Maximum Primary Stream Array Size.

Note: The above item shall not appear when **XHCI Mode is set as [Disabled].*

EHCI1/ EHCI2

Use this item to enable or disable USB EHCI (USB 2.0) support. One EHCI controller must always be enabled. The optional settings are: [Enabled]; [Disabled].

USB Port Pre-Port Disable Control

Use this item to control each of the USB ports (0~13) disabling.

PE2 Configuration/ PE3 Configuration/Mini PCIE Slot Configuration

Press [Enter] to make settings for PE2/PE3/ Mini PCIE slot configuration.

PE2 Slot/ PE3 Slot/Mini PCIE Slot

Use this item to control corresponding PCI Express Root Port.

ASPM Support

Use this item to set the ASPM level. The optional settings are: [Disabled]; [L0s]; [L1]; [L0SL1]; [Auto].

URR

Use this item to enable or disable PCI Express unsupported request reporting.

FER

Use this item to enable or disable PCI Express device Fatal Error Reporting.

NFER

Use this item to enable or disable PCI Express device Non-Fatal Error Reporting.

CER

Use this item to enable or disable PCI Express device Correctable Error Reporting.

CT0

Use this item to enable or disable PCI Express Completion Timer T0.

SEFE

Use this item to enable or disable Root PCI Express System Error on Fatal Error.

SENF

Use this item to enable or disable Root PCI Express System Error on Non-Fatal Error.

SECE

Use this item to enable or disable Root PCI Express System Error on Correctable Error.

PME SCI

Use this item to enable or disable PCI Express PME SCI.

Hot Plug

Use this item to enable or disable PCI Express Hot Plug.

PCIe Speed

Use this item to select PCI Express port speed.

Extra Bus Reserved

Use this item to set extra bus reserved (0-7) for bridges behind this root bridge.

Reserved Memory

Use this item to set reserved memory and prefetchable memory (1-20MB) range for this root bridge.

Reserved I/O

User this item to set reserved I/O (4L/8K/12K/16K/20K) range for this root bridge.

Azalia HD Audio

The optional settings are: [Disabled]; [Enabled];[Auto].

Azalia Internal HDMI Codec

Use this item to enable or disable internal HDMI codec for Azalia.

Onboard LAN1 Controller

Use this item to enable or disable onboard LAN controller.

Wake on LAN1 from S5

Use this item to enable or disable integrated LAN to wake the system.

Onboard LAN2 Device

Use this item to control the PCI Express root port.

DeepSx Power Policies

Use this item to configure the Deep Sx Mode configuration.

High Precision Event Timer Configuration

High Precision Timer

The optional settings are: [Enabled]; [Disabled].

Restore AC Power Loss

Use this item to select AC power state when power is re-applied after a power failure. The optional settings are: [Power Off]; [Power On]; [Last State].

System Agent (SA) Configuration

Press [Enter] to make settings for the following sub-items:

Enable NB Card

The optional settings are: [Enabled]; [Disabled].

Graphics Configuration

Press [Enter] to make further settings for Graphics Configuration.

Graphics Configuration

Primary Display

The optional settings are: [Auto]; [IGFX]; [PEG]; [PCI].

Internal Graphics

The optional settings are: [Auto]; [Disabled]; [Enabled].

CTT Size

The optional settings are: [1MB]; [2MB].

Aperture Size

The optional settings are: [128MB]; [256MB]; [512MB].

DVMT Pre-Allocated

Use this item to select DVMT 5.0 pre-allocated (fixed) graphics memory size used by the internal graphics device.

DVMT Total Gfx Mem

Use this item to select DVMT 5.0 total graphics memory size used by the internal graphics device.

GFx Low Power Mode

The optional settings are: [Disabled]; [Enabled]. This option is applicable for SFF only.

NB PCIe Configuration

Press [Enter] to make settings for the following sub-items:

NB PCIe Configuration:

PEG0-Gen X

The optional settings are: [Auto]; [Gen1]; [Gen2]; [Gen3].

PEG0 ASPM

The optional settings are: [Disabled]; [Auto]; [ASPM L0s]; [ASPM L1]; [ASPM L0sL1].

Enable PEG

The optional settings are: [Auto]; [Enabled]; [Disabled].

De-emphasis Control

The optional settings are: [-6 dB]; [-3.5 dB].

Memory Configuration

Press [Enter] to make settings for the following sub-items:

DIMM profile

Use this item to select DIMM timing profile that should be used.

Memory Frequency Limiter

Use this item to set maximum memory frequency selection in Mhz.

MMode Support

The optional settings are: [Auto]; [1N Mode]; [2N Mode].

Memory Remap

Use this item to enable or disable memory remap above 4G. The optional settings are: [Enabled]; [Disabled].

3-9 Boot Menu

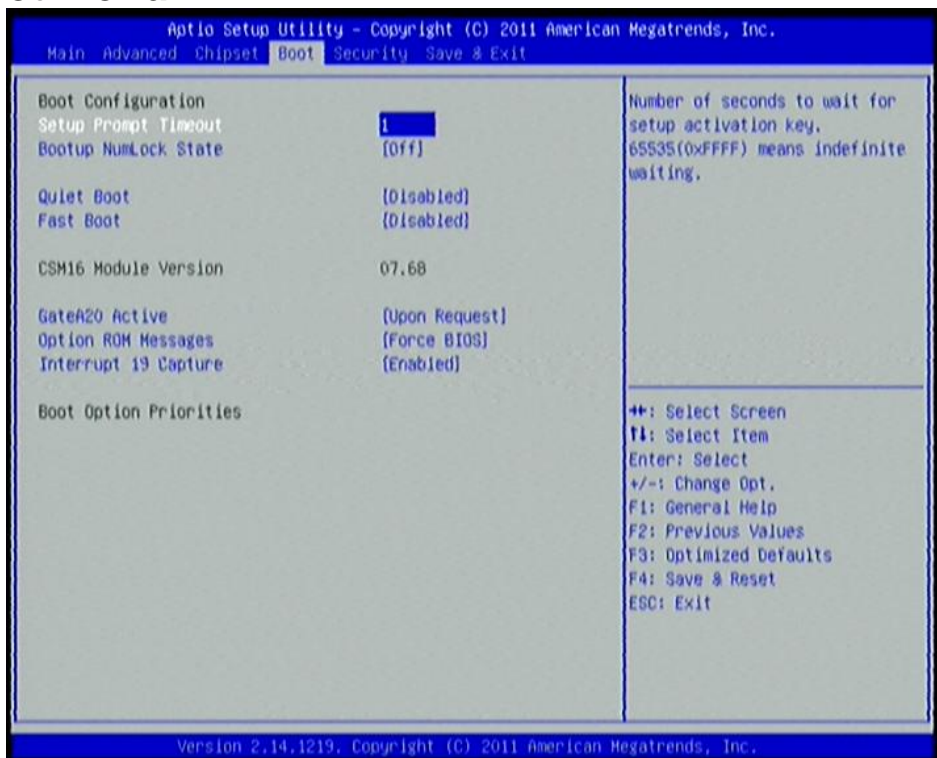

Boot Configuration:

Setup Prompt Timeout

Use this item to set number of seconds to wait for setup activation key.

Bootup Numlock State

Use this item to select keyboard numlock state. The optional settings are: [On]; [Off].

Quiet Boot

The optional settings are: [Enabled]; [Disabled].

Fast Boot

The optional settings are: [Enabled]; [Disabled].

Gate A20 Active

The optional settings are: [Upon Request]; [Always].

Option ROM Message

Use this item to set display mode for option ROM. The optional settings are: [Force BIOS]; [Keep Current].

Interrupt 19 Capture

The optional settings are: [Enabled]; [Disabled].

Boot Option Priorities:

Boot Option #1/ Boot Option #2

Use this item to decide system boot order from available options.

Hard Drive BBS Priorities

Use this item to set the order of the legacy devices in this group.

**Note: The above two items is only available when responding devices are connected.*

3-10 Security Menu

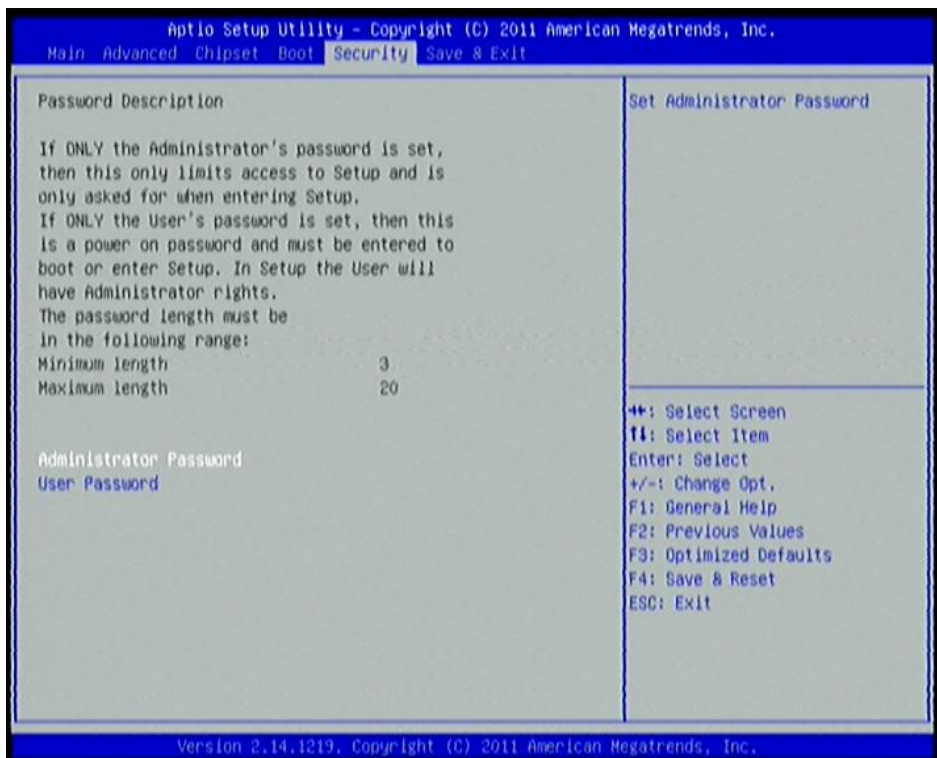

Security menu allow users to change administrator password and user password

settings.

3-11 Save & Exit Menu

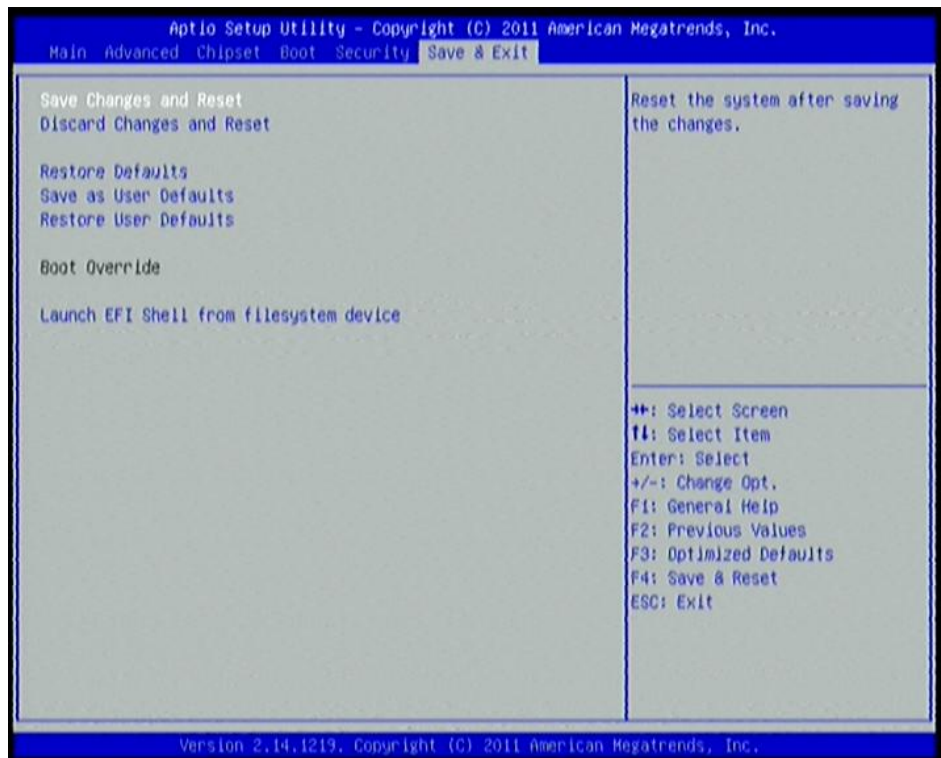

Save Changes and Reset

This item allows user to reset the system after saving the changes.

Discard Changes and Reset

This item allows user to reset the system without saving any changes.

Restore Defaults

Use this item to restore /load default values for all the setup options.

Save as User Defaults

Use this item to save the changes done so far as user defaults.

Restore User Defaults

Use this item to restore defaults to all the setup options.

Launch EFI Shell from file system device

This item is for attempts to launch EFI shell application (Shell x64.efi) from one of the available filesystem devices.