

Technical Manual
Of
Intel Bay Trail Series CPU
Based
3.5'' SBC

NO.G03-NF532-F

Revision: 1.0

Release date: May 26, 2015

Trademark:

- * Specifications and Information contained in this documentation are furnished for information use only, and are subject to change at any time without notice, and should not be construed as a commitment by manufacturer.

Environmental Protection Announcement

Do not dispose this electronic device into the trash while discarding. To minimize pollution and ensure environment protection of mother earth, please recycle.



TABLE OF CONTENT

ENVIRONMENTAL SAFETY INSTRUCTION	iv
USER'S NOTICE	v
MANUAL REVISION INFORMATION	v
ITEM CHECKLIST	v
CHAPTER 1 INTRODUCTION OF THE MOTHERBOARD	
1-1 FEATURE OF MOTHERBOARD	1
1-2 SPECIFICATION	2
1-3 LAYOUT DIAGRAM	3
CHAPTER 2 HARDWARE INSTALLATION	
2-1 JUMPER SETTING	9
2-2 CONNECTORS AND HEADERS	13
2-2-1 CONNECTORS	13
2-2-2 HEADERS	15
CHAPTER 3 INTRODUCING BIOS	
3-1 ENTERING SETUP	21
3-2 BIOS MENU SCREEN	22
3-3 FUNCTION KEYS	23
3-4 GETTING HELP	23
3-5 MEMU BARS	24
3-6 MAIN MENU	25
3-7 ADVANCED MENU	26
3-8 CHIPSET MENU	36
3-9 SECURITY MENU	38
3-10 BOOT MENU	39
3-11 SAVE & EXIT MENU	40



Environmental Safety Instruction

- Avoid the dusty, humidity and temperature extremes. Do not place the product in any area where it may become wet.
- 0 to 60 centigrade is the suitable temperature. (The figure comes from the request of the main chipset)
- Generally speaking, dramatic changes in temperature may lead to contact malfunction and crackles due to constant thermal expansion and contraction from the 'welding spots' that connect components and PCB. Computer should go through an adaptive phase before it boots when it is moved from a cold environment to a warmer one to avoid condensation phenomenon. These water drops attached on PCB or the surface of the components can bring about phenomena as minor as computer instability resulted from corrosion and oxidation from components and PCB or as major as short circuit that can burn the components. Suggest starting the computer until the temperature goes up.
- The increasing temperature of the capacitor may decrease the life of computer. Using the close case may decrease the life of other device because the higher temperature in the inner of the case.
- Attention to the heat sink when you over-clocking. The higher temperature may decrease the life of the device and burned the capacitor.

USER'S NOTICE

COPYRIGHT OF THIS MANUAL BELONGS TO THE MANUFACTURER. NO PART OF THIS MANUAL, INCLUDING THE PRODUCTS AND SOFTWARE DESCRIBED IN IT MAY BE REPRODUCED, TRANSMITTED OR TRANSLATED INTO ANY LANGUAGE IN ANY FORM OR BY ANY MEANS WITHOUT WRITTEN PERMISSION OF THE MANUFACTURER.

THIS MANUAL CONTAINS ALL INFORMATION REQUIRED TO USE THIS MOTHER-BOARD SERIES AND WE DO ASSURE THIS MANUAL MEETS USER'S REQUIREMENT BUT WILL CHANGE, CORRECT ANY TIME WITHOUT NOTICE. MANUFACTURER PROVIDES THIS MANUAL "AS IS" WITHOUT WARRANTY OF ANY KIND, AND WILL NOT BE LIABLE FOR ANY INDIRECT, SPECIAL, INCIDENTAL OR CONSEQUENTIAL DAMAGES (INCLUDING DAMAGES FOR LOSS OF PROFIT, LOSS OF BUSINESS, LOSS OF USE OF DATA, INTERRUPTION OF BUSINESS AND THE LIKE).

PRODUCTS AND CORPORATE NAMES APPEARING IN THIS MANUAL MAY OR MAY NOT BE REGISTERED TRADEMARKS OR COPYRIGHTS OF THEIR RESPECTIVE COMPANIES, AND THEY ARE USED ONLY FOR IDENTIFICATION OR EXPLANATION AND TO THE OWNER'S BENEFIT, WITHOUT INTENT TO INFRINGE.

Manual Revision Information

Reversion	Revision History	Date
1.0	First Edition	May 26, 2015

Item Checklist

- Motherboard
- User's Manual
- DVD for motherboard utilities
- Cable(s)

Chapter 1

Introduction of the Motherboard

1-1 Feature of Motherboard

- Onboard Intel® Bay Trail Series Processor, with low power consumption never denies high performance
- Support single channel DDRIII 1333 MHz SODIMM, up to 8GB
- Support 1 * SATAII device
- Onboard 1* full-size mSATA/ Mini-PCIE slot
- Onboard 1* half-size Mini-PCIE slot
- Onboard 1* SIM card slot
- Onboard 2 * RJ-45 gigabit Ethernet LAN port
- Support DVI-D output & VGA output
- Support USB 3.0 data transport demand
- Support CPU Smart FAN
- Compliance with ErP standard
- Support Watchdog function

1-2 Specification

Spec	Description
Design	<ul style="list-style-type: none">● 3.5" SBC; 6 layers; PCB size: 14.8x 10.2 cm
Embedded CPU	<ul style="list-style-type: none">● Intel® Bay Trail series SoC CPU
Memory Slot	<ul style="list-style-type: none">● 1 * DDRIII SODIMM Slot for un-buffered Single Channel DDRIII 1333 MHz SDRAM, up to 8GB
Expansion Slot	<ul style="list-style-type: none">● 1* Full-size Mini-PCIE/mSATA slot (MMPE)● 1* Half-size Mini-PCIE slot (MPE)● 1* SIM card slot
LAN Chip	<ul style="list-style-type: none">● Integrated with dual Realtek RTL8111G PCI-E Gigabit LAN chips● Support Fast Ethernet LAN function of providing 10/100/1000Mbps Ethernet data transfer rate
BIOS	<ul style="list-style-type: none">● AMI 64MB Flash ROM
Rear I/O	<ul style="list-style-type: none">● 1* DC 9V~24V power-in connector● 3* USB 2.0 port● 2* RJ-45 LAN port● 1* DVI-D port● 1* USB 3.0 port● Audio Line Out port x1
Internal I/O	<ul style="list-style-type: none">● 1* SATAII 3Gb/s port● 1* SATA Power connector● 1* CPUFAN header● 1* Front panel audio header● 1* SPDIF Out header● 4* Serial port header● 2* 9-pin USB 2.0 header (Expansibile to 4* USB 2.0 ports)● 1* GPIO header

	<ul style="list-style-type: none">● 1* SM_BUS header● 1* PS2KBMS header● 1* Front panel header● 2* LAN LED activity header● 1* VGA port header
--	--

1-3 Layout Diagram

Rear IO Panel Diagram:

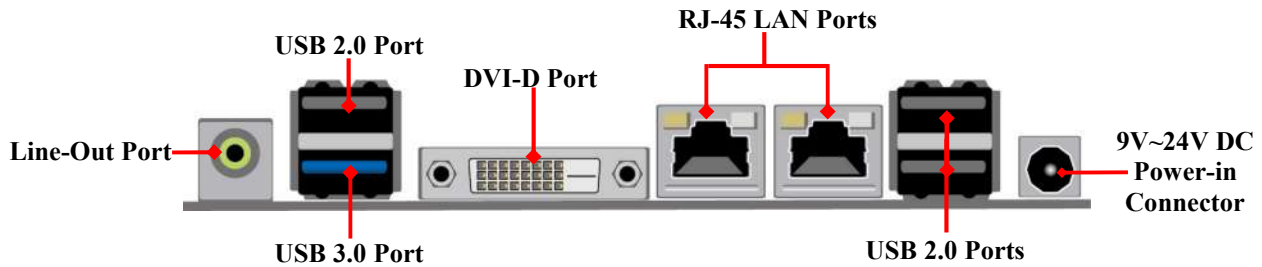

Internal Diagram-Front Side:

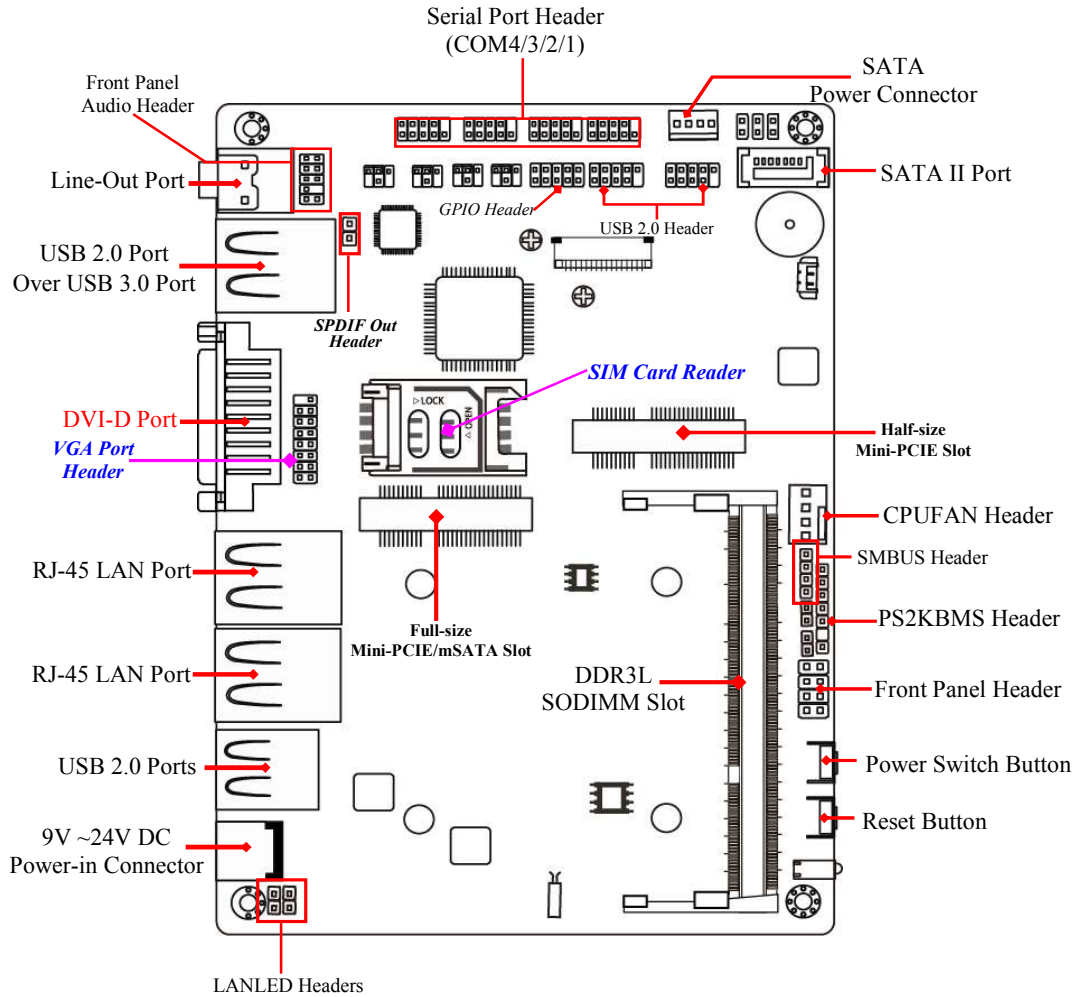

Internal Diagram-Back Side:

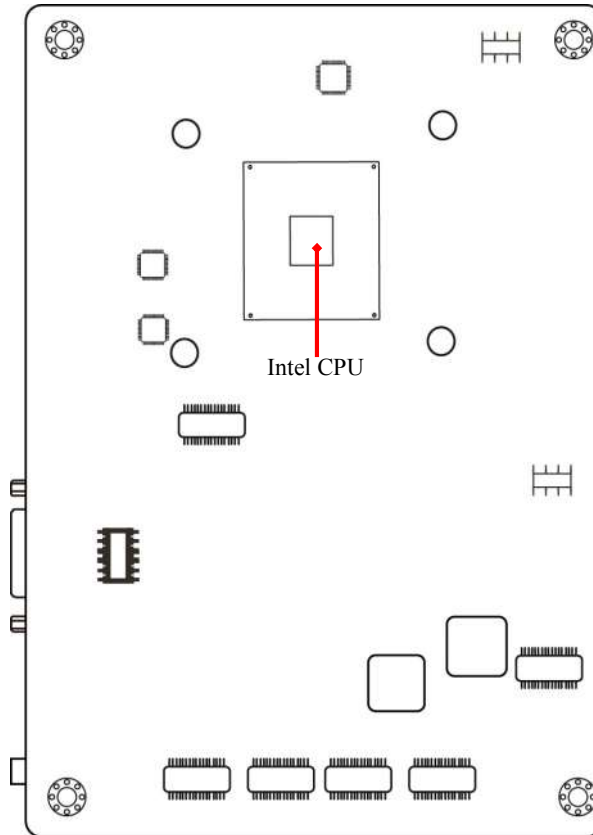

Jumper Position:

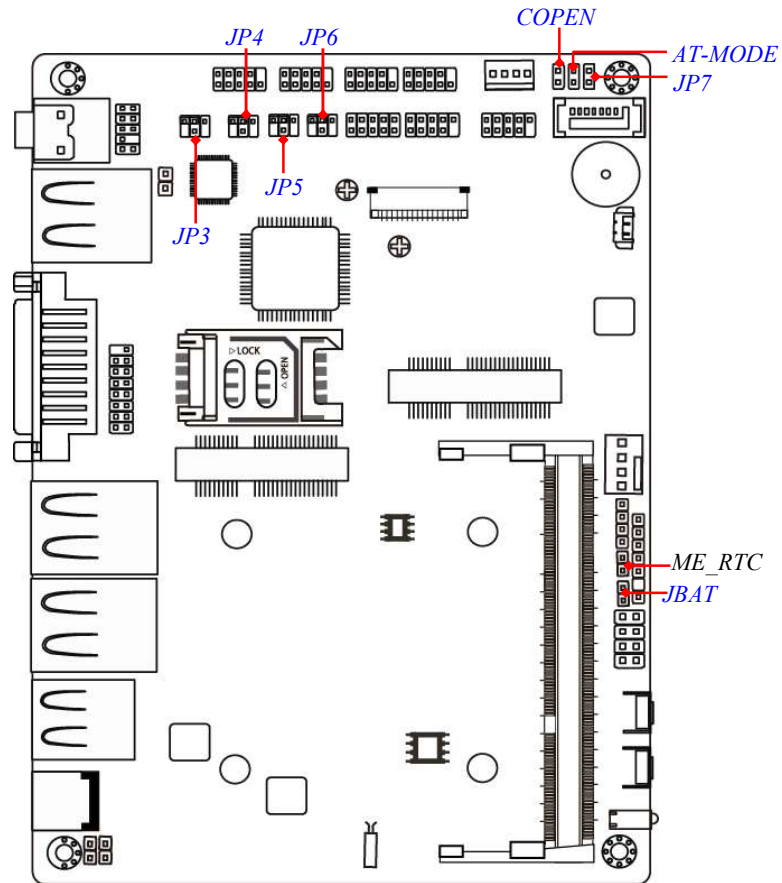

Jumper

Jumper	Name	Description
JP3	COM4 Header Pin9 Function Select	4-Pin Block
JP4	COM3 Header Pin9 Function Select	4-Pin Block
JP5	COM2 Header Pin9 Function Select	4-Pin Block
JP6	COM1 Header Pin9 Function Select	4-Pin Block
ME_RTC	Clear ME Function Setting	2-Pin Block
JBAT	CMOS RAM Clear Function Setting	2-Pin Block
COPEN	Case Open Message Display Function	2-Pin Block
AT_MODE	AT Mode Function Select	2-Pin Block
JP7	Security Measure Function Select	2-Pin Block

Connectors

Connector	Name
DCIN1	DC 9V~24V Power-in Connector
SATA1	SATAII Port Connector
PWOUT	SATA Power out Connector
CPUFAN	CPUFAN Connector
USB1/USB3(Top)	USB 2.0 Port Connector X3
USB3(Bottom)	USB 3.0 Port Connectors
LAN1/LAN2	RJ-45 LAN Port Connector X2
DVI	DVI-D Port Connector
AUDIO	Audio Line Out Connector

Headers

Header	Name	Description
FP_AUDIO	Front Panel Audio Header	9-pin Block
SPDIFOUT	SPDIF Out Header	2-pin Block
COM1/2/3/4	Serial Port Header X4	9-pin Block
GPIO	GPIO Header	10-pin Block
USB2/ USB4	USB 2.0 Header	9-pin Block
SMBUS	SMBUS Header	4-pin Block
PS2KBMS	PS2KBMS Header	6-pin Block
FP	Front Panel Header(PWR LED/ HDD LED/ /Power Button /Reset)	8-pin Block
LAN1LED/LAN2LED	LAN Activity LED Header X2	2-pin Block
VGA	VGA Port Header	15-pin Block

Chapter 2

Hardware Installation

2-1 Jumper Setting

(1) JP3 (4-pin): COM4 Header Pin9 Function Select

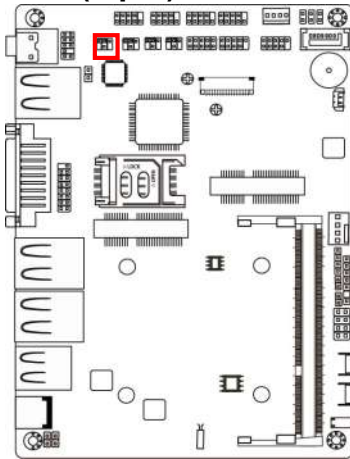

JP3→COM4

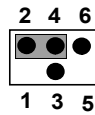

2-4 Closed:
RI=RS232;

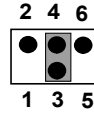

3-4 Closed:
RI= 5V;

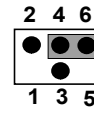

4-6 Closed:
RI= 12V.

(2) JP4 (4-pin): COM3 Header Pin9 Function Select

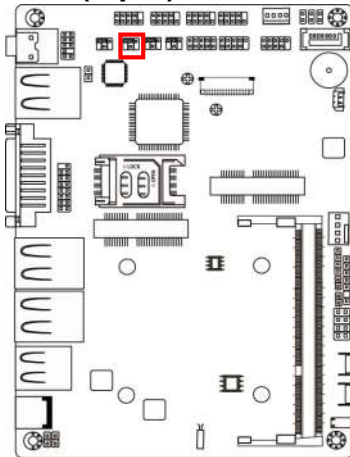

JP4→COM3

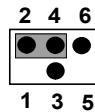

2-4 Closed:
RI=RS232;

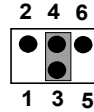

3-4 Closed:
RI= 5V;

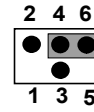

4-6 Closed:
RI= 12V.

(3) JP5 (4-pin): COM2 Header Pin9 Function Select

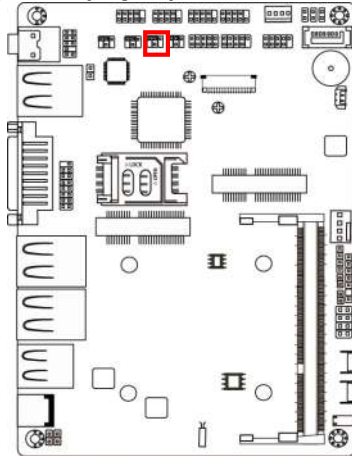

JP5→COM2

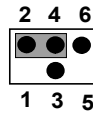

2-4 Closed:
RI=RS232;

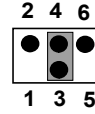

3-4 Closed:
RI= 5V;

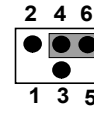

4-6 Closed:
RI= 12V.

(4) JP6 (4-pin): COM1 Header Pin9 Function Select

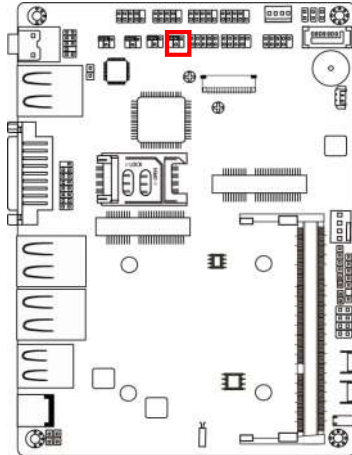

JP6→COM1

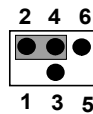

2-4 Closed:
RI=RS232;

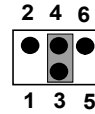

3-4 Closed:
RI= 5V;

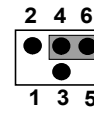

4-6 Closed:
RI= 12V.

(5) ME_RTC (2-pin): Clear ME Function Setting

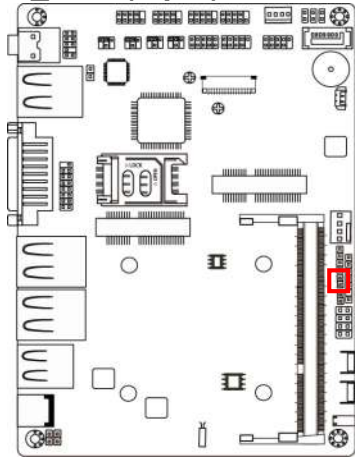

ME_RTC



1-2 Open: Normal;



1-2 Closed: Clear ME

(6) JBAT (2-pin): Clear CMOS

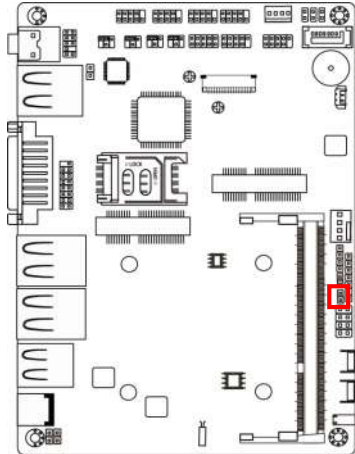

JBAT



1-2 Open: Normal;



1-2 Closed: Clear CMOS

CMOS Clear Setting

(7)COPEN (2-pin): Case Open Message Display Function Select

Pin 1-2 Closed: When Case open function pin short to GND, the Case open function was detected. When Used, needs to enter BIOS and enable 'Case Open Detect' function. In this case if your case is removed, next time when you restart your computer, a message will be displayed on screen to inform you of this.

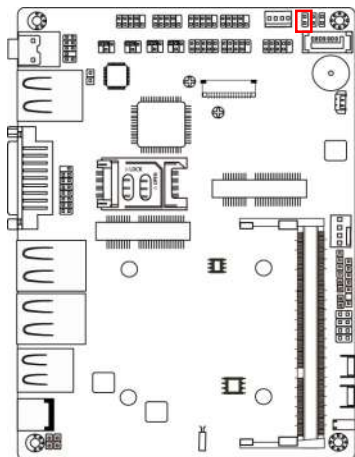

COPEN



(8)AT_MODE (2-pin): AT Mode Function Select

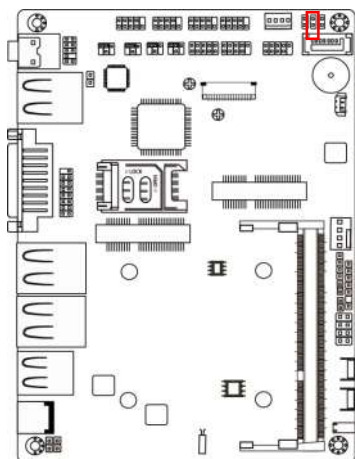

AT-MODE



1-2 Open: Normal;



1-2 Closed: AT Mode Selected.

***ATX Mode Selected:** Press power button to power on after power input ready;
AT Mode Selected: Directly power on as power input ready.

(9)JP7 (2-pin): Security Measure Function Select

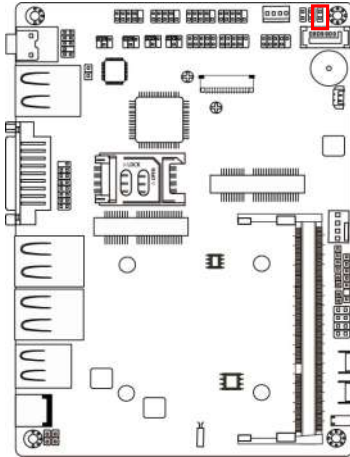

JP7



1-2 Open: Enable Security Measures
in the Flash Descriptor(Default);



1-2 Closed: Disable Security Measures
in the Flash Descriptor(Override).

2-2 Connectors and Headers

2-2-1 Connectors

(1) Rear I/O Connectors

Rear IO Panel Diagram:

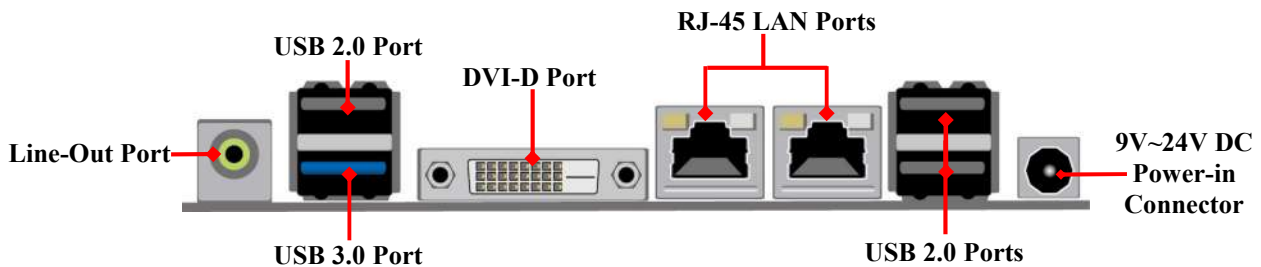

(2) SATA1(7-Pin Block) : SATAII Port connector

SATA1 port is a high-speed SATAII port that supports 3GB/s transfer rate.

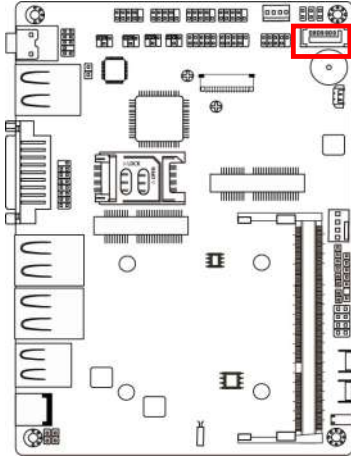

Pin No.	Definition
1	GND
2	TXP
3	TXN
4	GND
5	RXN
6	RXP
7	GND

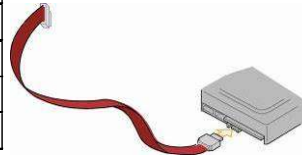

(3) PWOUT (4-pin): SATA Power Connector

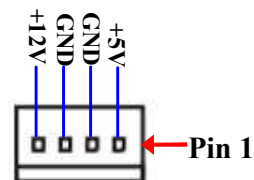
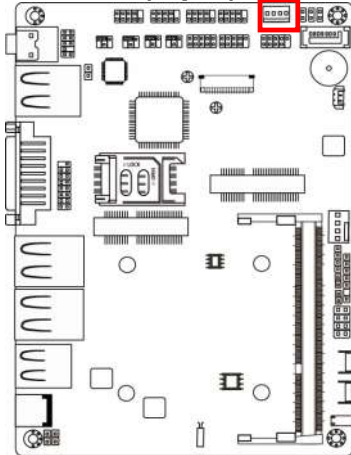

(4) CPUFAN (4-pin): CPUFAN Connector

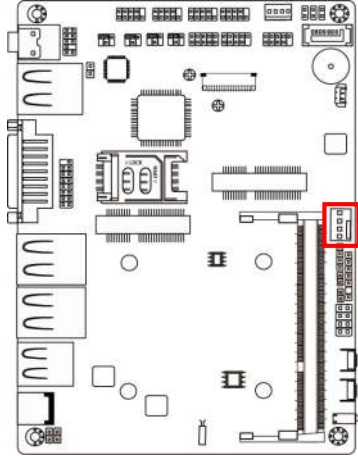

CPUFAN

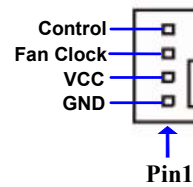

2-2-2 Headers

(1) FP_AUDIO (9-pin): Line-Out, MIC-In Header

This header connects to Front Panel Line-out, MIC-In connector with cable.

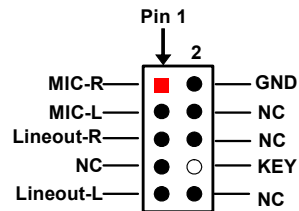
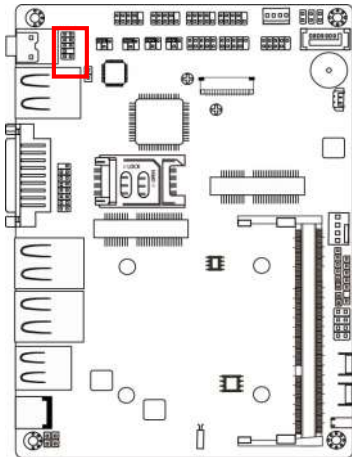

Line-Out, MIC Header

(2) SPDIFOUT (2-pin): SPDIF Out Header

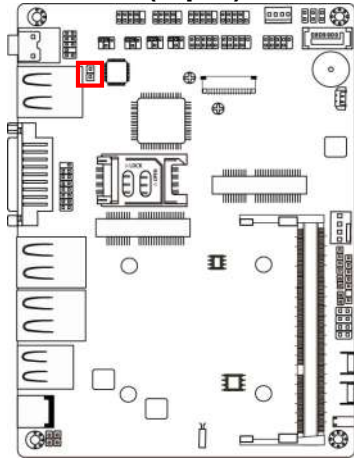

(3) COM4/3/2/1 (9-pin): Serial Port Headers

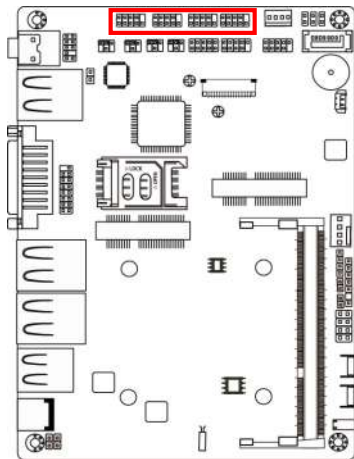

Pin NO.	RS232	*RS422 <i>(for COM1)</i>	*RS485 <i>(for COM1)</i>
Pin 1	DCD	TX-	DATA-
Pin 2	RXD	TX+	DATA+
Pin 3	TXD	RX+	NC
Pin 4	DTR	RX-	NC
Pin 5	GNG	GND	GND
Pin 6	DSR	NC	NC
Pin 7	RTS	NC	NC
Pin 8	CTS	NC	NC
Pin 9	RI	NC	NC

***Notice:** RS422, RS485 function is supported by COM1 header only, with compatible COM cable for RS422 or RS 485 function. User also needs to go to BIOS to set 'Transmission Mode Select' for COM1 (refer to Page 27).

(4) GPIO (10-pin): GPIO Header

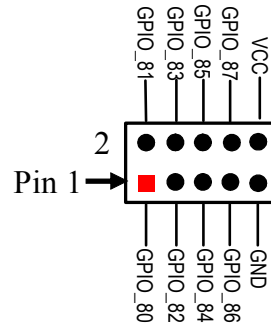
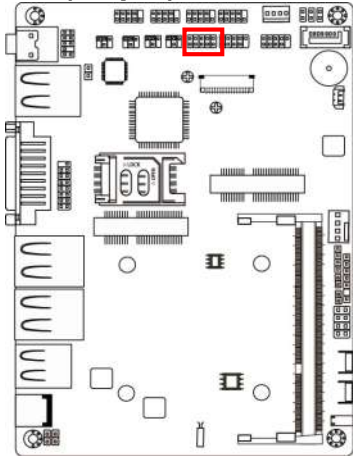

(5) USB2/USB4 (9-pin): USB 2.0 Port Header

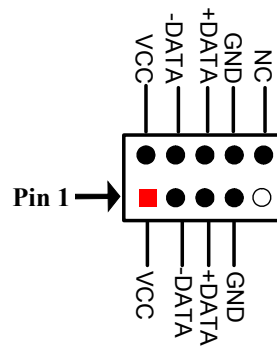
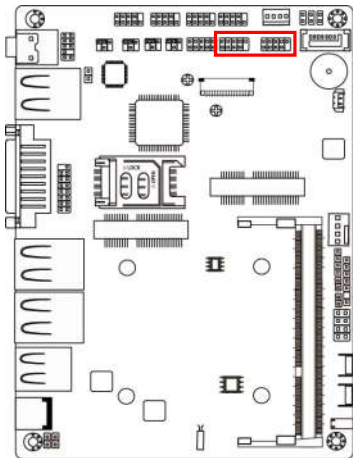

(6) SMBUS (4-Pin): SM BUS Header

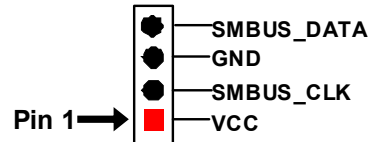
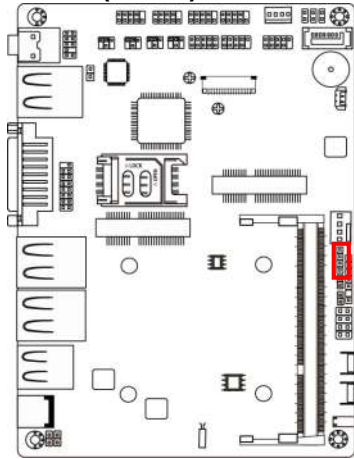

(7) PS2KBMS (6-pin): PS/2 Keyboard & Mouse Header

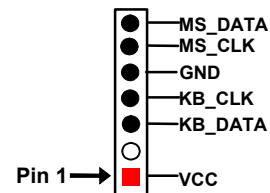
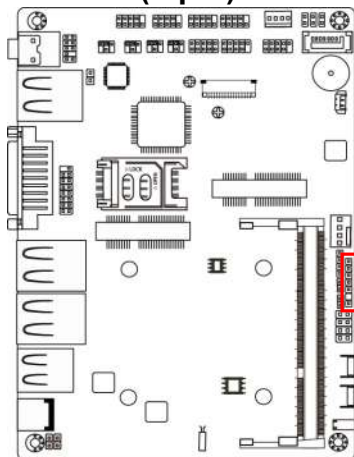

(8) FP (8-pin) : Front Panel Header

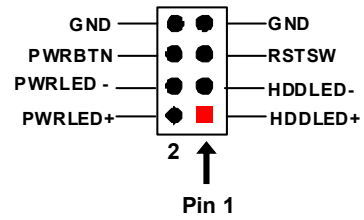
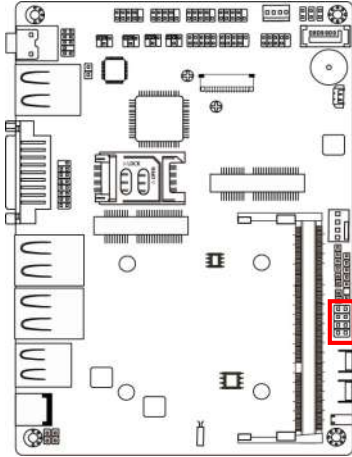

(9) LAN1LED/LAN2LED (2-pin): LAN Activity LED Headers

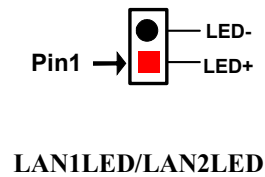
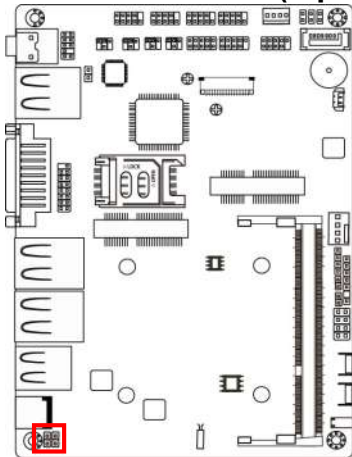

(10) VGA (15-pin): VGA Port Header

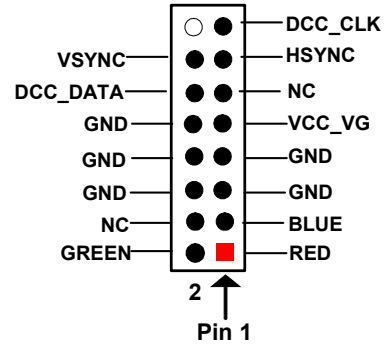
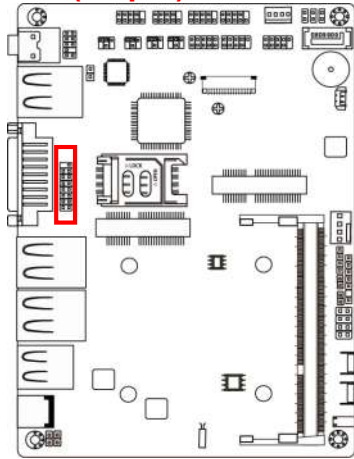

Chapter 3

Introducing BIOS

Notice! The BIOS options in this manual are for reference only. Different configurations may lead to difference in BIOS screen and BIOS screens in manuals are usually the first BIOS version when the board is released and may be different from your purchased motherboard. Users are welcome to download the latest BIOS version form our official website.

The BIOS is a program located on a Flash Memory on the motherboard. This program is a bridge between motherboard and operating system. When you start the computer, the BIOS program will gain control. The BIOS first operates an auto-diagnostic test called POST (power on self test) for all the necessary hardware, it detects the entire hardware device and configures the parameters of the hardware synchronization. Only when these tasks are completed done it gives up control of the computer to operating system (OS). Since the BIOS is the only channel for hardware and software to communicate, it is the key factor for system stability, and in ensuring that your system performance as its best.

3-1 Entering Setup

Power on the computer and by pressing immediately allows you to enter Setup. If the message disappears before your respond and you still wish to enter Setup, restart the system to try again by turning it OFF then ON or pressing the “RESET” button on the system case. You may also restart by simultaneously pressing <Ctrl>, <Alt> and <Delete> keys. If you do not press the keys at the correct time and the system does not boot, an error message will be displayed and you will again be asked to

Press to enter Setup; press < F7> for Popup Menu.

3-2 BIOS Menu Screen

The following diagram show a general BIOS menu screen:

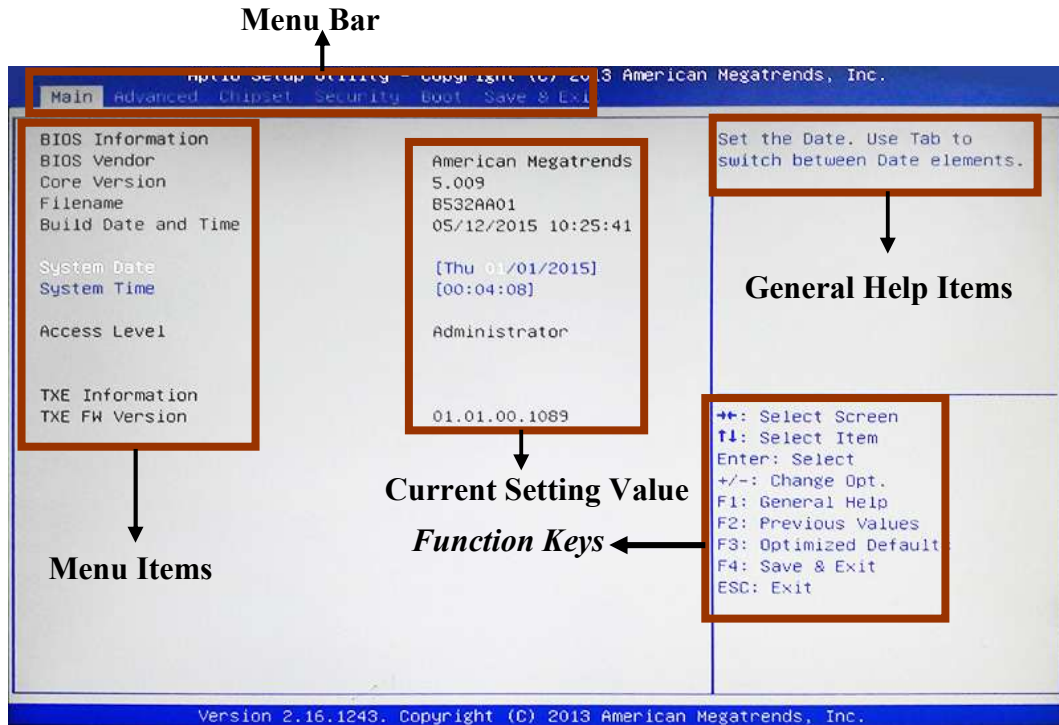

BIOS Menu Screen

3-3 Function Keys

In the above BIOS Setup main menu of, you can see several options. We will explain these options step by step in the following pages of this chapter, but let us first see a short description of the function keys you may use here:

- Press ←→ (left, right) to select screen;
- Press ↑↓ (up, down) to choose, in the main menu, the option you want to confirm or to modify.
- Press <Enter> to select.
- Press <+>/<-> keys when you want to modify the BIOS parameters for the active option.
- [F1]: General help.
- [F2]: Previous value.
- [F3]: Optimized defaults.
- [F4]: Save & Exit.
- Press <Esc> to quit the BIOS Setup.

3-4 Getting Help

Main Menu

The on-line description of the highlighted setup function is displayed at the top right corner the screen.

Status Page Setup Menu/Option Page Setup Menu

Press F1 to pop up a small help window that describes the appropriate keys to use and the possible selections for the highlighted item. To exit the Help Window, press <Esc>.

3-5 Menu Bars

There are six menu bars on top of BIOS screen:

Main	To change system basic configuration
Advanced	To change system advanced configuration
Chipset	To change chipset configuration
Security	Password settings
Boot	To change boot settings
Save & Exit	Save setting, loading and exit options.

User can press the right or left arrow key on the keyboard to switch from menu bar. The selected one is highlighted.

3-6 Main Menu

Main menu screen includes some basic system information. Highlight the item and then use the <+> or <-> and numerical keyboard keys to select the value you want in each item.

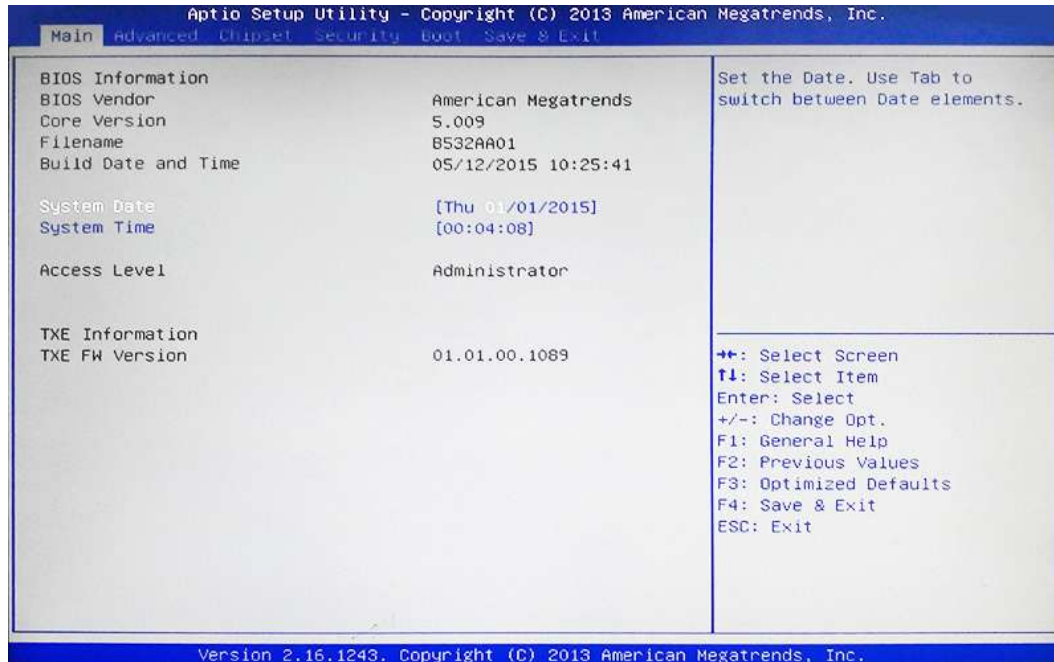

System Date

Set the date. Please use [Tab] to switch between data elements.

System Time

Set the time. Please use [Tab] to switch between time elements.

3-7 Advanced Menu

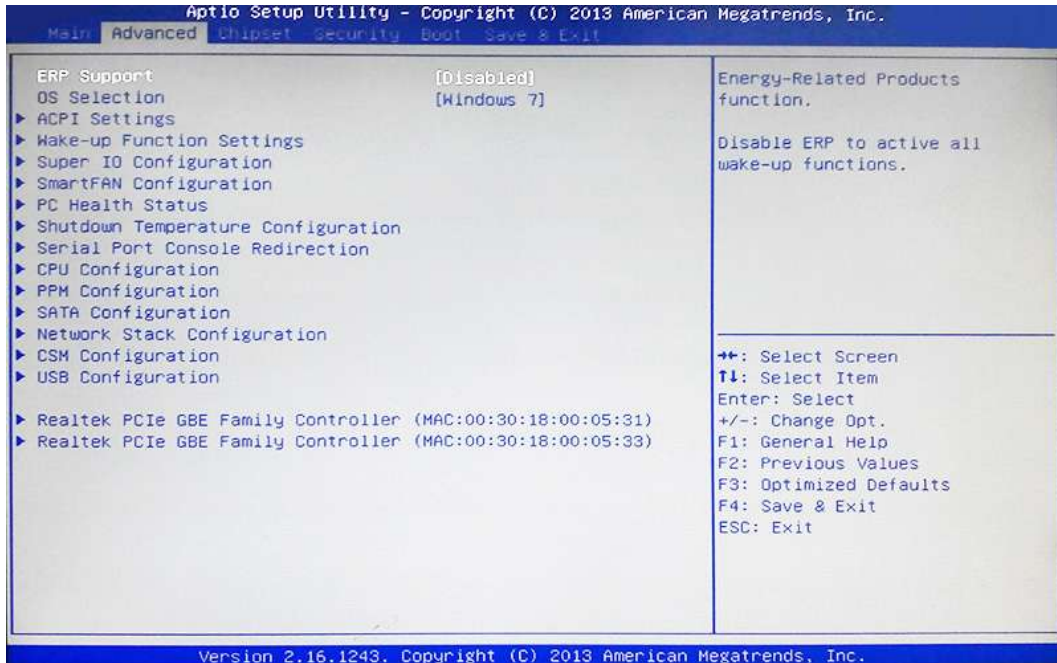

ERP Function

The optional settings: [Auto]; [Disabled].

This item should be set as **[Disabled]** if you wish to have all active wake-up functions.

OS Selection

The optional settings: [Android]; [Windows 8.X]; [Windows 7].

In the case that OS selection is set as [Windows 7], XHCI & EHCI mode will be auto configuration.

**Note: User need to go to this item to select the OS mode before installing corresponding OS driver, otherwise problems will occur when installing the driver.*

▶ **ACPI Settings**

Press [Enter] to make settings for the following sub-item:

ACPI Settings

ACPI Sleep State

Use this item to select the highest ACPI sleep state the system will enter when the suspend button is pressed.

The optional settings are: [Suspend Disabled]; [S3 (Suspend to RAM)].

▶ **Wake-up Function Settings**

Press [Enter] to make settings for the following sub-items:

Wake System with Fixed Time

Use this item to enable or disable system wake on alarm event. When set as [Enabled], system will wake on the hour/min/sec specified.

PS2 KB/MS Wake-up

The optional settings: [Disabled]; [Enabled].

Use this item to enable or disable PS2 KB/MS wake-up from S3/S4/S5 state.

**This item will only show when 'ERP Support' is set as [Disabled].*

▶ **Super IO Configuration**

Press [Enter] to make settings for the following sub-items:

Super IO Configuration

▶ **Serial Port 1 Configuration**

Press [Enter] to make settings for the following items:

Serial Port

Use this item to enable or disable serial port (COM).

Change Settings

Use this item to select an optimal setting for super IO device.

Transmission Mode Select

The optional settings are: [RS422]; [RS232]; [RS485].

Mode Speed Select

The optional settings are: [RS232/RS422/RS485=250kbps]; [RS232=1Mbps, RS422/RS485=10Mbps].

Serial Port FIFO Mode

The optional settings are: [16-Byte FIFO]; [32-Byte FIFO]; [64-Byte FIFO]; [128-Byte FIFO].

▶ **Serial Port 2 Configuration/ Serial Port 3 Configuration/ Serial Port 4 Configuration**

Press [Enter] to make settings for the following items:

Serial Port

Use this item to enable or disable serial port (COM).

Change Settings

Use this item to select an optimal setting for super IO device.

Serial Port FIFO Mode

The optional settings are: [16-Byte FIFO]; [32-Byte FIFO]; [64-Byte FIFO]; [128-Byte FIFO].

OS Select For Serial Port

Use this item to enable serial port support for Windows or Linux OS.

The optional settings are: [Windows]; [Linux].

WatchDog Timer

Use this item to enable or disable WatchDog Timer Control. When set as [Enabled], the following sub-items shall appear:

WatchDog Timer Value

User can set a value in the range of [4] ~ [255].

WatchDog Timer Unit

The optional settings are: [Sec.]; [Min.].

WatchDog Wake-up Timer in ERP

This item support WDT wake-up while ERP function is set as [Auto].

The optional settings are: [Enabled]; [Disabled].

When set as [Enabled], the following sub-items shall appear:

WatchDog Timer Value in ERP

The setting range is [10] ~ [4095] seconds, or [1]~[4095] minutes.

WatchDog Timer Unit

The optional settings are: [Sec.]; [Min.].

ATX Power Emulate AT Power

This item displays current Emulate AT Power Status, motherboard power On/Off control by power supply. User needs to select 'AT or ATX Mode' on MB jumper at first (refer to **Page 12**, Jumper AT_MODE for ATX Mode & AT Mode Select).

Case Open Detect

This item controls detect case open function.
The optional settings are: [Enabled]; [Disabled].

▶ **SmartFAN Configuration**

Press [Enter] to make settings for SmartFan Configuration:

CPU Fan Type

The optional settings are: [4-Pin]; [3-Pin].

CPUFAN Smart Mode

When set as [Enabled], the following sub-items shall appear:

CPUFAN Full-Speed Temperature

Use this item to set CPUFAN full speed temperature. Fan will run at full speed when above the pre-set temperature.

CPUFAN Full-Speed Duty

Use this item to set CPUFAN full speed duty. Fan will run at full speed when above the pre-set duty.

CPUFAN Idle-Speed Temperature

Use this item to set CPUFAN idle speed temperature. Fan will run at idle speed when below the pre-set temperature.

CPUFAN Idle-Speed Duty

Use this item to set CPUFAN idle speed duty. Fan will run at idle speed when below the pre-set duty.

▶ **PC Health Status**

Press [Enter] to view current hardware health status.

▶ **Shutdown Temperature Configuration**

Use this item to select system shutdown temperature.

The optional settings are: [Disabled]; [70° C/158° F]; [75° C/167° F]; [80° C/176°

F]; [85 ° C/185 ° F].

▶ **Serial Port Consol Redirection**

Press [Enter] to make settings for serial port redirection settings:

COM1

Console Redirection

The optional settings are: [Disabled]; [Enabled].

When set as [Enabled], user can make further settings in:

▶ **Console Redirection Settings**

The settings specify how the host computer and the remote computer (which the user is using) will exchange data. Both computers should have the same or compatible settings.

Press [Enter] to make settings for the following sub-items.

Terminal Type

The optional settings are: [VT100]; [VT100+]; [VT-UTF8]; [ANSI].

Bits per second

The optional settings are: [9600]; [19200]; [38400]; [57600]; [115200].

Data Bits

The optional settings are: [7]; [8].

Parity

The optional settings are: [None]; [Even]; [Odd];[Mark]; [Space].

Stop Bits

The optional settings are: [1]; [2].

Flow Control

The optional settings are: [None]; [Hardware RTS/CTS].

VT-UTF8 Combo Key Support

The optional settings are: [Disabled]; [Enabled].

Recorder Mode

The optional settings are: [Disabled]; [Enabled].

Resolution 100x31

The optional settings are: [Disabled]; [Enabled].

Legacy OS Redirection Resolution

The optional settings are: [80x24]; [80x25].

Putty Keypad

The optional settings are: [VT100]; [Linux]; [XTERMR6]; [SCO]; [ESCN]; [VT400].

Redirection After BIOS POST

The optional settings are: [Always Enable]; [BootLoader].

Serial Port for Out-of-Band Management

/Windows Emergency Management Services (EMS)

Console Redirection

The optional settings are: [Enabled]; [Disabled].

When set as [Enabled], user can make further settings in 'Console Redirection Settings':

▶ Console Redirection Settings

The settings specify how the host computer and the remote computer (which the user is using) will exchange data. Both computers should have the same or compatible settings.

Press [Enter] to make settings for the following sub-items.

Out-of-Band Mgmt Port

This item may or may not show up, depending on different configuration.

Terminal Type

The optional settings are: [VT100]; [VT100+]; [VT-UTF8]; [ANSI].

Bits per second

The optional settings are: [9600]; [19200]; [57600]; [115200].

Flow Control

The optional settings are: [None]; [Hardware RTS/CTS]; [Software Xon/Xoff].

Data Bits

The default setting is: [8].

**This item may or may not show up, depending on different configuration.*

Parity

The default setting is: [None].

**This item may or may not show up, depending on different configuration.*

Stop Bits

The default setting is: [1].

**This item may or may not show up, depending on different configuration.*

▶ **CPU Configuration**

Press [Enter] to view current CPU configuration and make settings for the following sub-items:

Limit CPUID Maximum

The optional settings: [Disabled]; [Enabled].

This item should be set as [Disabled] for Windows XP.

Execute Disable Bit

The optional settings: [Disabled]; [Enabled].

Hardware Prefetcher

The optional settings are: [Disabled]; [Enabled].

Use this item to turn on/off the Mid Level Cache (L2) streamer prefetcher.

Adjacent Cache Line Prefetch

The optional settings are: [Disabled]; [Enabled].

Use this item to enable or disable the Mid Level Cache (L2) prefetching of adjacent cache lines.

Intel Virtualization Technology

The optional settings are: [Disabled]; [Enabled].

When set as [Enabled], a VMM can utilize the additional hardware capabilities provided by Vanderpool Technology.

Power Technology

The optional settings: [Disabled]; [Energy Efficient].

▶ **PPM Configuration**

Press [Enter] to make settings for PPM Configuration:

PPM Configuration:

EIST

The optional settings are: [Disabled]; [Enabled].

Use this item to enable or disable Intel SpeedStep.

CPU C Status Report

Use this item to enable or disable CPU C status report to OS.

The optional settings: [Disabled]; [Enabled].

When set as [Enabled], the following sub-items shall appear:

Enhanced C state

Use this item to enable or disable CPU C state.

Max CPU C-state

This item controls Max C state that the processor will support.

The optional settings: [C7]; [C6]; [C1].

▶ **SATA Configuration**

Press [Enter] to make settings for the following sub-items:

SATA Configuration

SATA Port

The optional settings: [Enabled]; [Disabled].

SATA Mode

The optional settings are: [IDE Mode]; [AHCI Mode].

SATA Speed Support

The item is for user to set the maximum speed the SATA controller can support.

The optional settings are: [Gen1]; [Gen2].

SATA Port1

The optional settings are: [Enabled]; [Disabled].

mSATA/ SATA Port2

The optional settings are: [Enabled]; [Disabled].

▶ **Network Stack Configuration**

Press [Enter] to go to 'Network Stack' screen to make further settings.

Network Stack

The optional settings are: [Enabled]; [Disabled].

When set as [Enabled], the following sub-items shall appear:

Ipv4 PXE Support

The optional settings are: [Disabled]; [Enabled].

Use this item to enable Ipv4 PXE Boot Support. When set as [Disabled], Ipv4 boot optional will not be created.

Ipv6 PXE Support

The optional settings are: [Disabled]; [Enabled].

Use this item to enable Ipv6 PXE Boot Support. When set as [Disabled], Ipv4 boot optional will not be created.

PXE boot wait time

Use this item to set wait time to press [ESC] key to abort the PXE boot.

▶ **CSM Configuration**

Press [Enter] to make settings for the following sub-items:

Compatibly Support Module Configuration

Option ROM Message

The optional settings are: [Force BIOS]; [Keep Current].

INT19 Trap Response

The optional settings are: [Immediate]; [Postponed].

Option ROM execution order

Network

This item controls the execution of UEFI and legacy PXE OpROM.

The optional settings are: [Do not launch]; [UEFI only]; [Legacy only].

Storage

This item controls the execution of UEFI and Legacy Storage OpROM.

The optional settings are: [Do not launch]; [UEFI only]; [Legacy only]; [Legacy first]; [UEFI first].

Other PCI devices

This item determines OpROM execution policy for devices other than Network, storage or video.

The optional settings are: [UEFI first]; [Legacy Only].

▶ **USB Configuration**

Press [Enter] to make settings for the following sub-items:

USB Configuration

Legacy USB Support

The optional settings are: [Enabled]; [Disabled]; [Auto].

[Enabled]: To enable legacy USB support.

[Disabled]: To keep USB devices available only for EFI specification,

[Auto]: To disable legacy support if no USB devices are connected.

XHCI Hand-off

This is a workaround for OSES without XHCI hand-off support. The XHCI ownership change should be claimed by XHCI driver.

The optional settings are: [Enabled]; [Disabled].

EHCI Hand-off

This is a workaround for OSES without EHCI hand-off support. The EHCI ownership change should be claimed by EHCI driver.

The optional settings are: [Disabled]; [Enabled].

USB Mass Storage Driver Support

The optional settings are: [Disabled]; [Enabled].

USB hardware delay and time-outs:

USB Transfer time-out

Use this item to set the time-out value for control, bulk, and interrupt transfers.

The optional settings are: [1 sec]; [5 sec]; [10 sec]; [20 sec].

Device reset time-out

Use this item to set USB mass storage device start unit command time-out.

The optional settings are: [10 sec]; [20 sec]; [30 sec]; [40 sec].

Device power-up delay

Use this item to set maximum time the device will take before it properly reports itself to the host controller. 'Auto' uses default value: for a root port it is 100 ms, for a hub port the delay is taken from hub descriptor.

The optional settings are: [Auto]; [Manual].

Select [Manual] you can set value for the following sub-item: '**Device Power-up delay in seconds**'.

Device Power-up delay in seconds

The delay range is from 1 to 40 seconds, in one second increments.

▶ Realtek PCIe GBE Family Controller (MAC:XX:XX:XX:XX:XX:XX)

Use this item to get driver information and configure Realtek ethernet controller parameter.

▶ **Realtek PCIe GBE Family Controller (MAC:XX:XX:XX:XX:XX:XX)**

Use this item to get driver information and configure Realtek ethernet controller

3-8 Chipset Menu

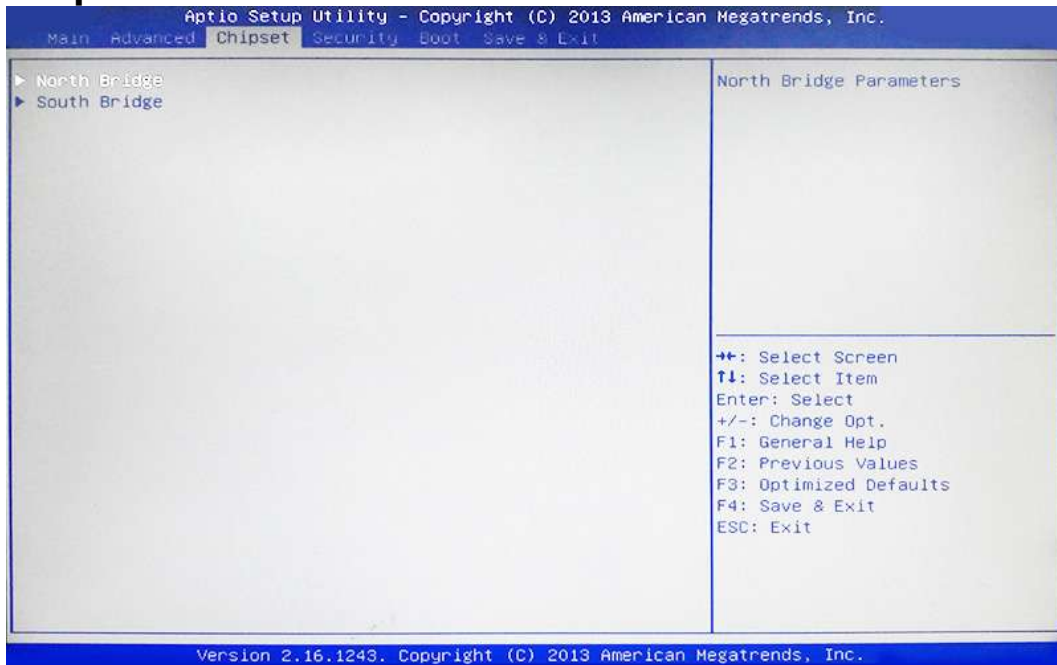

▶ **North Bridge**

Press [Enter] to view current using memory information and make settings for the following sub-items:

Intel IGD Configuration

IGD Turbo Enable

The optional settings are: [Enabled]; [Disabled].

Spread Spectrum Clock

The optional settings are: [Enabled]; [Disabled].

IGD Boot Type

Use this item to select preference display interface used when system boot.

The optional settings are: [Auto]; [CRT]; [HDMI/DVI].

▶ **South Bridge**

Press [Enter] to further setting USB device configuration.

▶ **Azalia HD Audio**

Press [Enter] to further setting USB device configuration.

Audio Configuration

Audio Controller

The optional settings are: [Disabled]; [Enabled].

Azalia HDMI Codec

Use this item to enable or disable internal HDMI codec for Azalia.

The optional settings are: [Disabled]; [Enabled].

▶ **USB Configuration**

Press [Enter] to make settings for the following sub-items:

USB Configuration

USB 3.0 Support

The optional settings are: [Auto]; [Disabled].

USB 3.0 Link Power Management

The optional settings are: [Enabled]; [Disabled].

USB 2.0 Support

The optional settings are: [Auto]; [Disabled].

**Note: 'USB 2.0 Support' is only applicable when 'USB 3.0 Support' is set as 'Disabled'.*

MMPE Slot Speed

Use this item to configure MMPE slot speed.

The optional settings are: [Auto]; [Gen2]; [Gen1].

MPE Controller

Use this item to enable or disable MPE controller.
The optional settings are: [Enabled]; [Disabled].

Speed

The optional settings are: [Auto]; [Gen2]; [Gen1].

Onboard Lan1 Controller

The optional settings are: [Enabled]; [Disabled].

Onboard Lan2 Controller

The optional settings are: [Enabled]; [Disabled].

Restore AC Power Loss

Use this item to select AC power state when power is re-applied after a power failure. The optional settings are: [Power Off]; [Power On]; [Last State].

3-9 Security Menu

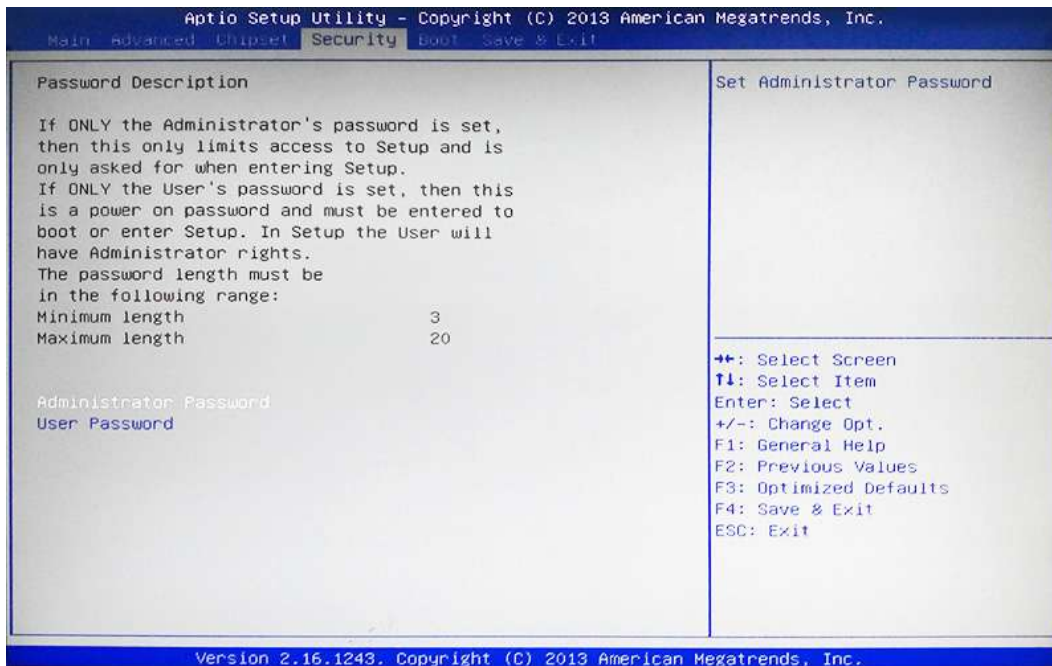

Security menu allow users to change administrator password and user password settings.

3-10 Boot Menu

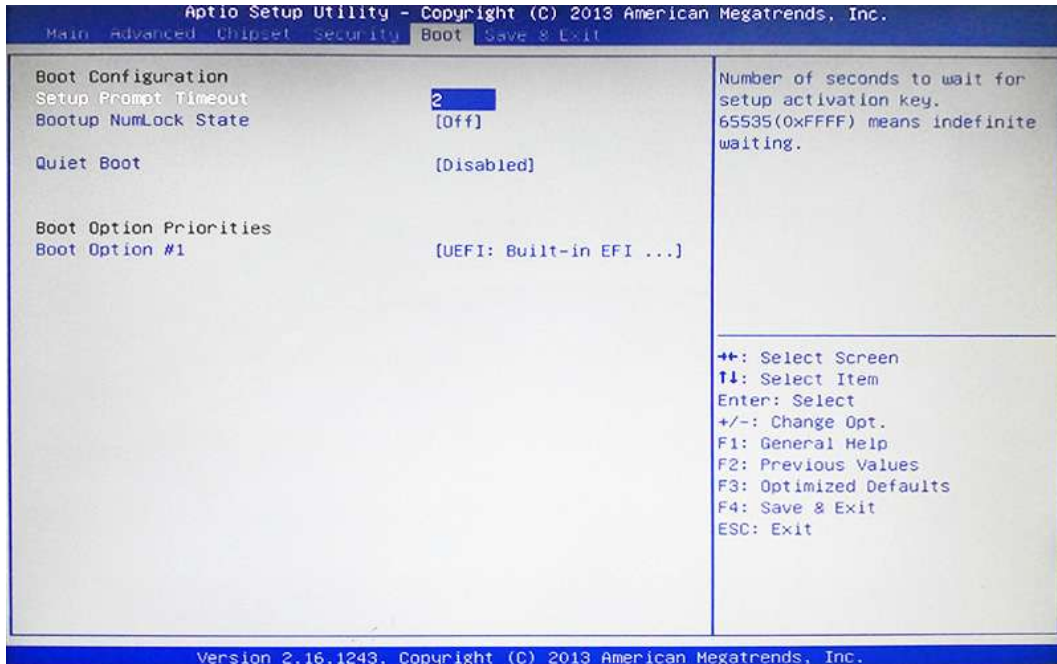

Boot Configuration

Setup Prompt Timeout

Use this item to set number of seconds to wait for setup activation key.

Bootup Numlock State

Use this item to select keyboard numlock state.

The optional settings are: [On]; [Off].

Quiet Boot

The optional settings are: [Disabled]; [Enabled].

Boot Option Priorities

Boot Option

The optional settings are: [UEFI: Built-in EFI Shell]; [Disabled].

3-11 Save & Exit Menu

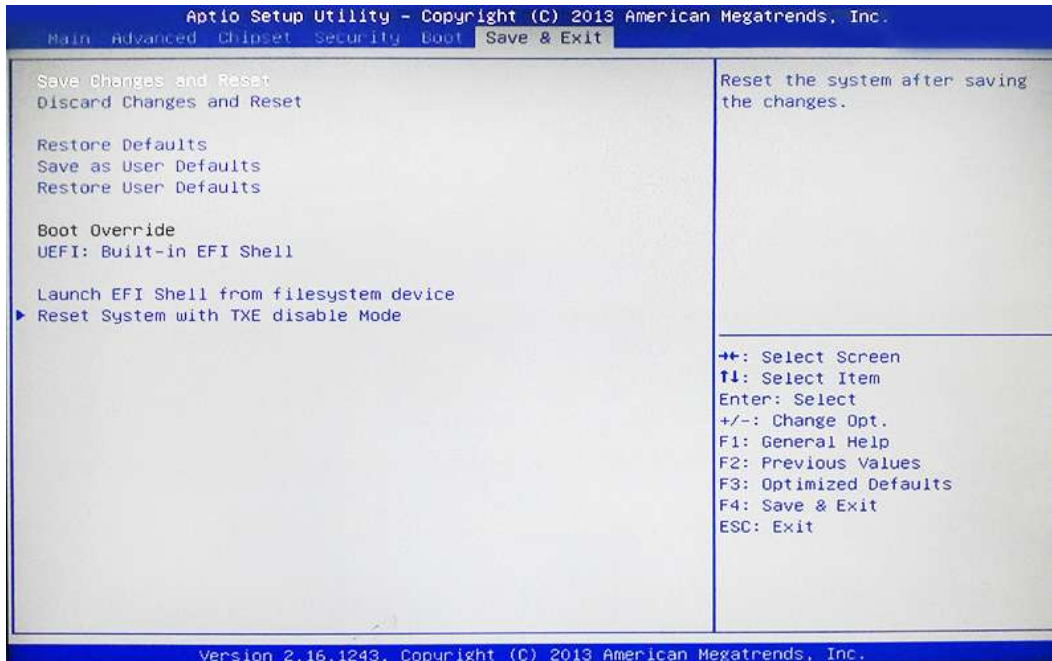

Save Changes and Reset

This item allows user to reset the system after saving the changes.

Discard Changes and Reset

This item allows user to reset the system without saving any changes.

Restore Defaults

Use this item to restore /load default values for all the setup options.

Save as User Defaults

Use this item to save the changes done so far as user defaults.

Restore User Defaults

Use this item to restore defaults to all the setup options.

Boot Oerride

UEFI: Built-in EFI Shell

Press this item and a dialogue box shall appear to ask if user wish to save configuration and reset.

Lauch EFI Shell from filesystem device

Use this item to launch EFI shell application (shell.efi) from one of the available filesystem device.

Reset System with TXE disable Mode

Press [Enter] for TXE to run into the temporary disable mode. Ignore if TXE Ignition FM.